



Réf. : SALP-NT-BORD-OP-16137-CN

Ed. : 1/Rév. : 4

Date : 14/06/2013

Page : 1

DORIS satellites models implemented in POE processing

SUMMARY :

During the last DORIS Analysis Working Group meeting (AWG) of the International DORIS Service (IDS) in Lisbon (Oct 21-22, 2010), the CNES POD Team brought to the attention of the AWGs that several of the satellite models available on the IDS website are wrong or not clearly presented.

An action was therefore taken by the CNES POD Team to provide a new document with the reference information needed to implement these models for the entire DORIS constellation. This document shall describe the current implementation in the ZOOM orbit determination software and replace the ftp://ftp.ids-doris.org/pub/ids/satellites/macromodels/*mod.pdf files on the IDS website.

Written by:

Luca CERRI DCT/SB/OR

Pascale FERRAGE DCT/ME/OT

Approved by

J.L. DULOT DCT/SB/OR

Diffusion : DCT/SB/OR (Tous) ,

DCT/ME/OT: Pascale Ferrage, Cédric Tourain

DCT/PO/AL : A.Auriol, C. Jayles



External diffusion : web site of the International DORIS Service ids-doris.org

History of modifications



Ed.	Rev.	Date	Modifications	Visa
1	0	15/11/2010	Initial version of the document	
1	1	18/03/2011	Add clarifications on Spot-5 solar panel offset	
1	2	11/04/2011	Add Introduction	
1	3	31/01/2011	Add HY2A satellite model	
1	4	14/06/2013	Add SARAL satellite model	

CONTENTS

1.	REFERENCES.....	5
2.	INTRODUCTION.....	6
3.	SPOT-2.....	8
3.1	MASS AND CENTER OF GRAVITY	8
3.2	SATELLITE ATTITUDE AND SOLAR PANEL ORIENTATION.....	8
3.3	MACROMODEL.....	9
3.4	DORIS PHASE CENTERS.....	9
4.	SPOT-3.....	9
4.1	MASS AND CENTER OF GRAVITY	9
4.2	SATELLITE ATTITUDE AND SOLAR PANEL ORIENTATION.....	9
4.3	MACROMODEL.....	10
4.4	DORIS PHASE CENTERS.....	10
5.	SPOT-4.....	10
5.1	MASS AND CENTER OF GRAVITY	10
5.2	SATELLITE ATTITUDE AND SOLAR PANEL ORIENTATION.....	10
5.3	MACROMODEL.....	10
5.4	DORIS PHASE CENTERS.....	11
6.	SPOT-5.....	11
6.1	MASS AND CENTER OF GRAVITY	11
6.2	SATELLITE ATTITUDE AND SOLAR PANEL ORIENTATION.....	11
6.3	DORIS PHASE CENTERS.....	12
7.	TOPEX-POSEIDON.....	12
7.1	MASS AND CENTER OF GRAVITY	12
7.2	SATELLITE ATTITUDE AND SOLAR PANEL ORIENTATION.....	13
7.3	MACROMODEL.....	14
7.4	DORIS PHASE CENTERS.....	14
8.	JASON-1	15
8.1	MASS AND CENTER OF GRAVITY	15
8.2	SATELLITE ATTITUDE AND SOLAR PANEL ORIENTATION.....	15
8.3	MACROMODEL.....	15
8.4	DORIS PHASE CENTERS.....	16

 <p>cnés CENTRE NATIONAL D'ÉTUDES SPATIALES</p>			<p>Réf. : SALP-NT-BORD-OP-16137-CN</p> <p>Ed. : 1/Rév. : 4</p> <p>Date : 14/06/2013</p> <p>Page : 4</p>
---------------------------------------------------------------------------------------------------------------------------------------------	-----------------------------------------------------------------------------------	-----------------------------------------------------------------------------------	---------------------------------------------------------------------------------------------------------

9.	JASON-2	16
9.1	MASS AND CENTER OF GRAVITY	16
9.2	SATELLITE ATTITUDE AND SOLAR PANEL ORIENTATION	17
9.3	MACROMODEL	17
9.4	DORIS PHASE CENTERS	17
10.	ENVISAT	18
10.1	MASS AND CENTER OF GRAVITY	18
10.2	SATELLITE ATTITUDE AND SOLAR PANEL ORIENTATION	18
10.3	MACROMODEL	19
10.4	DORIS PHASE CENTERS	19
11.	CRYOSAT-2	20
11.1	MASS AND CENTER OF GRAVITY	20
11.2	SATELLITE ATTITUDE AND SOLAR PANEL ORIENTATION	21
11.3	MACROMODEL	21
11.3.1	<i>ESA macromodel</i>	21
11.3.2	<i>CNES macromodel</i>	21
11.4	DORIS PHASE CENTERS	21
12.	HY-2A	22
12.1	MASS AND CENTER OF GRAVITY	22
12.2	SATELLITE ATTITUDE AND SOLAR PANEL ORIENTATION	22
12.3	MACROMODEL	23
12.4	DORIS PHASE CENTERS	23
13.	SARAL	23
13.1	MASS AND CENTER OF GRAVITY	24
13.2	SATELLITE ATTITUDE AND SOLAR PANEL ORIENTATION	24
13.3	MACROMODEL	24
13.4	DORIS PHASE CENTERS	24
14.	APPENDIX 1 - EXAMPLE OF COMPUTATION OF THE SOLAR RADIATION PRESSURE	25
15.	APPENDIX 2 - ESTIMATED EMPIRICAL FORCES	28

			<p>Réf. : SALP-NT-BORD-OP-16137-CN</p> <p>Ed. : 1/Rév. : 4</p> <p>Date : 14/06/2013</p> <p>Page : 5</p>
-----------------------------------------------------------------------------------	-----------------------------------------------------------------------------------	-----------------------------------------------------------------------------------	---------------------------------------------------------------------------------------------------------

1. REFERENCES

[1] Modeling of DORIS instruments

a) ftp://ftp.ids-doris.org/pub/ids/satellites/DORIS_instrument_modelling_1G_envisat.pdf

b) ftp://ftp.ids-doris.org/pub/ids/satellites/DORIS_instrument_modelling_2GM.pdf

[2] ENVISAT-1 MISSION CFI SOFTWARE MISSION CONVENTIONS DOCUMENT

http://eop-cfi.esa.int/CFI/ENV_CFI_DOCS/mcd2.0.pdf

[3] Cryosat-2 Precise Orbit Context, CS-TN-ESA-SY-0239

ftp://ftp.ids-doris.org/pub/ids/satellites/CryoSat-2_Precise_Orbit_Context.pdf

[4]

CryoSat-2 : Characteristics for DORIS calibration and POD processing, Annexe 5

ftp://ftp.ids-doris.org/pub/ids/satellites/CryoSat-2_CharacteristicsForDORISCalibrationPODprocessing.pdf



[5] DORISMail No 0552 : Jason-2 satellite model for POD <ftp://ftp.ids-doris.org/pub/ids/dorismail/dorismail.0552>

[6] L. Cerri, J. P. Berthias, W. I. Bertiger, B. J. Haines, F. G. Lemoine, F. Mercier, J. C. Ries, P. Willis, N. P. Zelensky, M. Ziebart. 2010. Precision Orbit Determination Standards for the Jason Series of Altimeter Missions. Marine Geodesy, Volume 33, Issue S1 2010 , pages 379 – 418.

[7] Cerri et al. , Jason-2 POD strategy, DORIS Analysis Working Group meeting (AWG) of the International DORIS Service - June 5-6, 2008 http://www.ids-doris.org/documents/report/AWG200806/IDSAWG0806_LCerri_Jason2PODStrategy.pdf

[8] SARAL CHARACTERISTICS FOR DORIS CALIBRATION PLAN AND POD PROCESSING, SRL-SYS-NT-066-CNES, *Issue 2, Revision 2 (03/05/2013)*

ftp://ftp.ids-doris.org/pub/ids/satellites/Saral_CharacteristicsForDORISCalibrationPlanAndPODProcessing.pdf

			Réf. : SALP-NT-BORD-OP-16137-CN Ed. : 1/Rév. : 4 Date : 14/06/2013 Page : 6
-----------------------------------------------------------------------------------	-----------------------------------------------------------------------------------	-----------------------------------------------------------------------------------	--------------------------------------------------------------------------------------

2. INTRODUCTION

This document describes the satellite models implemented in the ZOOM orbit determination software (used by the CNES SOD for POE processing). For IDS users, it shall be considered as the reference document for the DORIS satellite models..

For different reasons (estimation after launch, ...) some values adopted may be different from the values given by the DORIS system team at the beginning of each mission.

The list of the identified differences for all DORIS satellites is given here below and will be updated when needed:

SPOT-2: no difference

SPOT-3: initial center of gravity

Different values for the X, Y, Z coordinates in the file of mass and center of mass time evolution:
<ftp://ftp.ids-doris.org/pub/ids/satellites/sp3mass.txt>

SPOT4: no difference

SPOT5: no difference



TOPEX: no difference

Jason-1: initial center of gravity

Different values for the X coordinate in the file of mass and center of mass time evolution:
<ftp://ftp.ids-doris.org/pub/ids/satellites/ja1mass.txt>

JASON2: no difference

ENVISAT: no difference

 <p>cnes CENTRE NATIONAL D'ÉTUDES SPATIALES</p>	 <p>DORIS</p>	 <p>IDS</p>	<p>Réf. : SALP-NT-BORD-OP-16137-CN</p> <p>Ed. : 1/Rév. : 4</p> <p>Date : 14/06/2013</p> <p>Page : 7</p>
---------------------------------------------------------------------------------------------------------------------------------------------	-------------------------------------------------------------------------------------------------------	-----------------------------------------------------------------------------------------------------	---------------------------------------------------------------------------------------------------------

CRYOSAT-2: no difference

3. SPOT-2

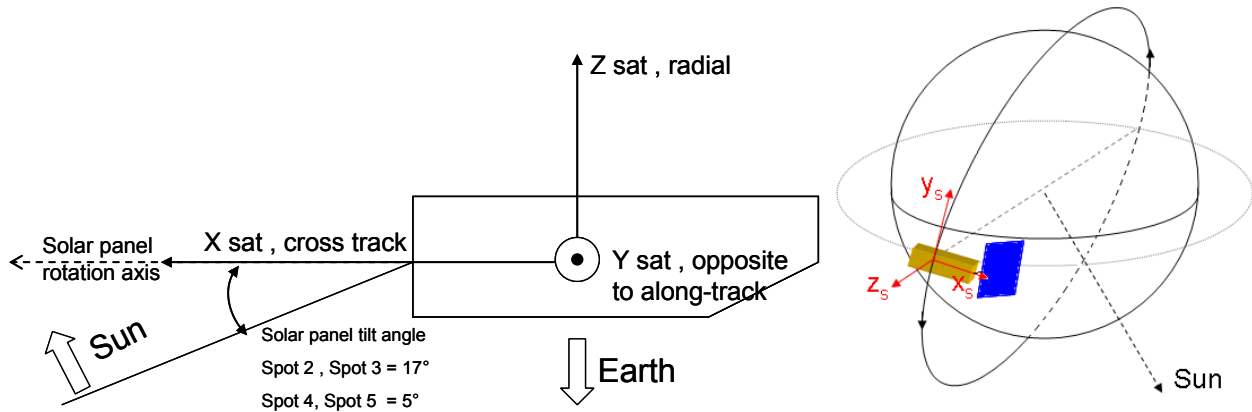

Figure 1 Schematic view of a SPOT satellite at descending node; the picture on the left is a view from the positive Ysat axis.

3.1 MASS AND CENTER OF GRAVITY

Initial values of mass and center of gravity coordinates in satellite reference frame

```
// Mass (kg) // X cog (m) // Y cog (m) // Z cog (m) //
1864.0      -1.612      0.009      0.025
```

The actual values of the satellite mass and CoG coordinates are obtained by adding the offsets available at <ftp://ftp.ids-doris.org/pub/ids/satellites/sp2mass.txt>

3.2 SATELLITE ATTITUDE AND SOLAR PANEL ORIENTATION

The satellite attitude model is fixed with respect to the local orbital reference frame in such a way that :

The satellite X axis is oriented as the cross-track direction

The satellite Y axis is oriented opposite to the along-track direction

The satellite Z axis is oriented as the radial direction.

The solar panel is tilted of 17° from the rotation axis (Xsat, cross-track) as shown in figure 1. The solar array rotates around Xsat axis in order to be oriented as well as possible towards the sun.

3.3 MACROMODEL

The optical and infrared properties of the macromodel and the plate surfaces are given below.

				// Optical properties			// Infrared properties		
// Surf (m ²)	// Normal	in sat ref frame		// spec	// diff	// abs	// spec	// diff	// abs
3.515	1.	0.	0.	0.5400	0.0700	0.3900	0.2100	0.0300	0.7600
3.515	-1.	0.	0.	0.5400	0.0700	0.3900	0.2100	0.0300	0.7600
6.51	0.	1.	0.	0.5400	0.0700	0.3900	0.2200	0.0300	0.7500
6.51	0.	-1.	0.	0.5400	0.0700	0.3900	0.2200	0.0300	0.7500
6.69	0.	0.	1.	0.5400	0.0700	0.3900	0.2600	0.0400	0.7000
6.69	0.	0.	-1.	0.5400	0.0700	0.3900	0.2600	0.0400	0.7000
// Solar array									
19.5	to sun			0.1600	0.1600	0.6800	0.1000	0.0600	0.8400
19.5	opposite to sun			0.1600	0.1600	0.6800	0.1000	0.0600	0.8400

3.4 DORIS PHASE CENTERS

Position of DORIS 2GHz Phase center in satellite reference frame:

X (m) // Y (m) // Z (m) //

-0.770 -0.330 -1.305

Position of DORIS 400MHz phase center in satellite reference frame:

X (m) // Y (m) // Z (m) //

-0.770 -0.330 -1.110

4. SPOT-3

4.1 MASS AND CENTER OF GRAVITY

SPOT-3 satellite has the same platform as SPOT-1 and SPOT-2. However, precise coordinates of the center of gravity in satellite reference frame are not available. We place the origin of the satellite reference frame at the center of gravity.

// Mass (kg) // X cog (m) // Y cog (m) // Z cog (m) //

1875.2 0.0 0.0 0.0

The evolution of the satellite mass and of the center of gravity coordinates is not available.

4.2 SATELLITE ATTITUDE AND SOLAR PANEL ORIENTATION

Identical to SPOT2.

4.3 MACROMODEL

The macromodel is identical to that of SPOT-2 .

4.4 DORIS PHASE CENTERS

Position of DORIS 2GHz Phase center in satellite reference frame:

```
X (m) // Y (m) // Z (m) //
0.814 -0.328 -1.288
```

Position of DORIS 400MHz phase center in satellite reference frame:

```
X (m) // Y (m) // Z (m) //
0.814 -0.328 -1.125
```

5. SPOT-4

5.1 MASS AND CENTER OF GRAVITY

SPOT-4 satellite is different from the previous generation of SPOT satellites. Initial values of mass and center of gravity coordinates in satellite reference frame are

```
// Mass (kg) // X cog (m) // Y cog (m) // Z cog (m) //
2753.960 -1.901 0.008 0.059
```

The actual values of the satellite mass and CoG coordinates are obtained by adding the offsets available at <ftp://ftp.ids-doris.org/pub/ids/satellites/sp4mass.txt>



5.2 SATELLITE ATTITUDE AND SOLAR PANEL ORIENTATION

Identical to previous SPOT satellites, but the solar panel tilt angle with respect to the rotation axis is 5° (figure 1).

5.3 MACROMODEL

The optical and infrared properties of the macromodel and the plate surfaces are given below.

```
// Surf(m²) // Normal in sat ref frame // Optical properties // Infrared properties
// spec // diff // abs // spec // diff // abs
3.50 1. 0. 0. 1.0000 -0.380 0.3800 0.2100 0.0300 0.7600
3.50 -1. 0. 0. 0.6300 0.8100 -0.4400 0.2100 0.0300 0.7600
7.70 0. 1. 0. 0.5600 0.3800 0.0600 0.2200 0.0300 0.7500
7.70 0. -1. 0. 0.5400 0.5000 -0.040 0.2200 0.0300 0.7500
9.00 0. 0. 1. 0.4700 0.1100 0.5200 0.2600 0.0400 0.7000
9.00 0. 0. -1. 0.4700 0.2500 0.2800 0.2600 0.0400 0.7000
// Solar array
24.8 to sun 0.1000 0.1500 0.7500 0.1000 0.0600 0.8400
```

 CENTRE NATIONAL D'ÉTUDES SPATIALES			Réf. : SALP-NT-BORD-OP-16137-CN Ed. : 1/Rév. : 4 Date : 14/06/2013 Page : 11
-------------------------------------------------------------------------------------------------------------------------	-----------------------------------------------------------------------------------	-----------------------------------------------------------------------------------	---------------------------------------------------------------------------------------

24.8 opposite to sun 0.2400 0.2400 0.5200 0.1000 0.0600 0.8400

5.4 DORIS PHASE CENTERS

Position of DORIS 2GHz Phase center in satellite reference frame:

```
X (m) // Y (m) // Z (m) //
-0.770    -0.330    -1.266
```

Position of DORIS 400MHz phase center in satellite reference frame:

```
X (m) // Y (m) // Z (m) //
-0.770    -0.330    -1.105
```

6. SPOT-5

6.1 MASS AND CENTER OF GRAVITY

SPOT-5 satellite is different from the previous generation of SPOT satellites. Initial values of mass and center of gravity coordinates in satellite reference frame are

```
// Mass (kg) // X cog (m) // Y cog (m) // Z cog (m) //
3056.000    -1.981    -0.003    -0.001
```

The actual values of the satellite mass and CoG coordinates are obtained by adding the offsets available at <ftp://ftp.ids-doris.org/pub/ids/satellites/sp5mass.txt>

6.2 SATELLITE ATTITUDE AND SOLAR PANEL ORIENTATION

Identical to previous SPOT satellites; the solar panel tilt angle with respect to the rotation axis is 5° (figure 1). The solar array rotates around Xsat axis in order to be oriented as well as possible towards the sun.

However, starting from Jan. 22, 2008, a positive 40° offset needs to be added to the optimal rotation angle.

Notice that this offset was reached after consecutive steps:

- on Jan. 15, an angle of +25° was applied;
- on Jan. 17, an additional offset of +10° was applied;
- on Jan. 22, a 3rd additional angle of +5° was applied.

The exact time of the day of each rotation offset is not available, so users should be **careful in processing SPOT-5 DORIS data from Jan. 15 to Jan. 22, 2008. Macromodel**

The optical and infrared properties of the macromodel and the plate surfaces are given below.

//Surf(m ²)	// Normal in sat ref frame			// Optical properties			// Infrared properties		
				// spec	// diff	// abs	// spec	// diff	// abs
7.21	1.	0.	0.	0.3460	0.2610	-0.108	0.0000	0.0000	0.0000
7.21	-1.	0.	0.	0.1610	0.0510	0.3940	0.0000	0.0000	0.0000
10.79	0.	1.	0.	0.4570	0.3660	0.0710	0.0000	0.0000	0.0000
10.79	0.	-1.	0.	0.4750	0.3680	0.0470	0.0000	0.0000	0.0000
11.79	0.	0.	1.	0.3700	0.2010	0.3410	0.0000	0.0000	0.0000
11.79	0.	0.	-1.	0.3930	0.2620	0.2400	0.0000	0.0000	0.0000
// Solar array									
24.8	to sun			0.1000	0.1500	0.7500	0.1000	0.0600	0.8400
24.8	opposite to sun			0.2400	0.2400	0.5200	0.1000	0.0600	0.8400

6.3 DORIS PHASE CENTERS

Position of DORIS 2GHz Phase center in satellite reference frame:

X (m) // Y (m) // Z (m) //

-0.52 -0.48 -1.415

Position of DORIS 400MHz phase center in satellite reference frame:

X (m) // Y (m) // Z (m) //

-0.52 -0.48 -1.253

7. TOPEX-POSEIDON

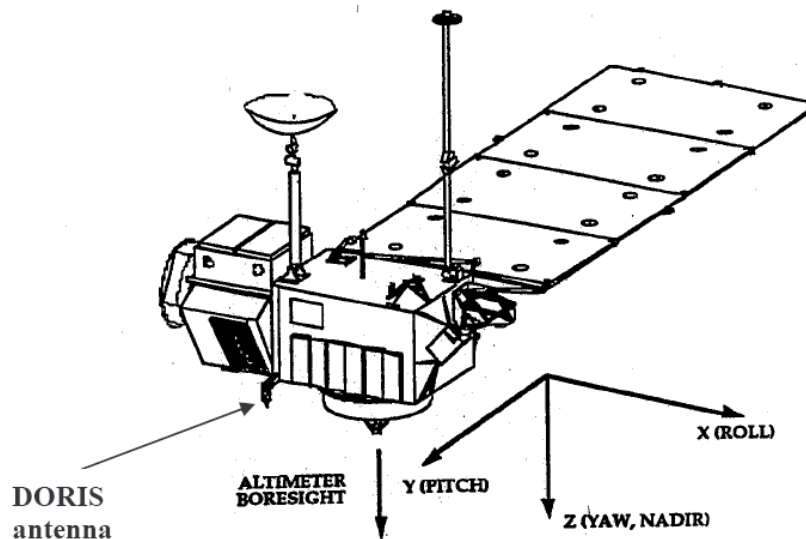

Figure 2 View of the TOPEX-Poseidon satellite

7.1 MASS AND CENTER OF GRAVITY

Initial values of mass and center of gravity coordinates in satellite reference frame are

```
// Mass (kg) // X cog (m) // Y cog (m) // Z cog (m) //
2419.3      0.0      0.0      0.0
```

The actual values of the satellite mass and CoG coordinates are obtained by adding the offsets available at <ftp://ftp.ids-doris.org/pub/ids/satellites/topmass.txt>

7.2 SATELLITE ATTITUDE AND SOLAR PANEL ORIENTATION

The pitch motion keeps the Z axis of the TOPEX/Poseidon spacecraft always pointed towards the Earth, perpendicular to the reference ellipsoid.

Concerning the yaw-motion, the nominal attitude law alternates yaw-steering and fixed-yaw regimes depending on the value of the Beta-prime angle (angle between the earth-sun direction and the orbit plane). Transitions from fixed to steered yaw regimes and back are called ramp-up and ramp-down, respectively. The satellite is kept in fixed yaw for $|\beta\text{-prime}| < 15^\circ$ (approximately) and in yaw-steering regime for other values of beta. When $\beta\text{-prime} \sim 0^\circ$ a complete yaw-flip occurs. Yaw-ramps and yaw-flip events are recorded in a file available at <ftp://ftp.ids-doris.org/pub/ids/satellites/topatt.txt>.

The nominal yaw angle for the yaw-steering regime is presented in figure 3. Note that in yaw-steering regime, the positive X axis points away from the sun.

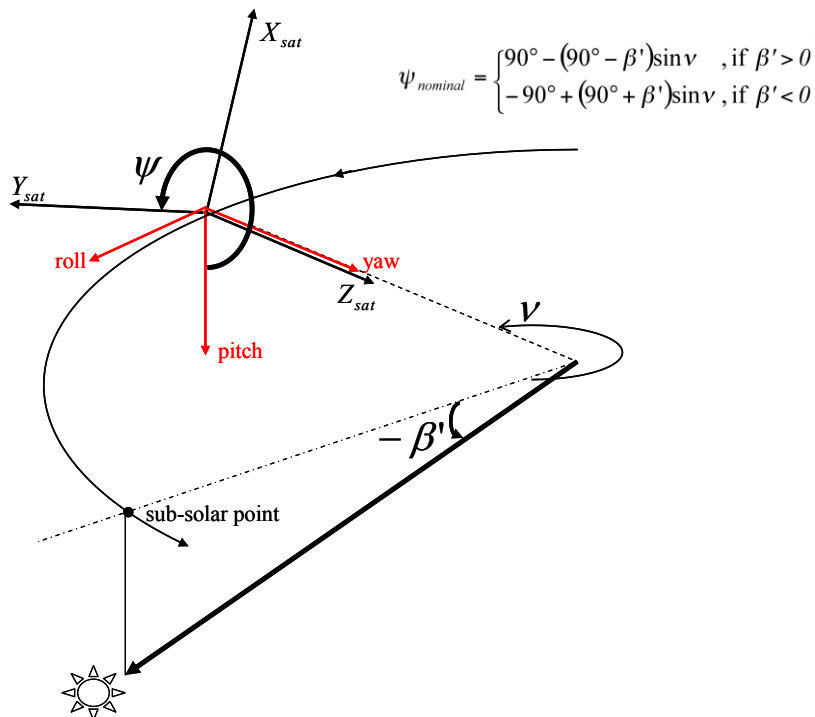

Figure 3 Schematic representation of TOPEX yaw-steering regime. The yaw angle is presented by the greek letter PSI.

In fixed yaw regime, the satellite X axis is oriented towards the along track direction when the satellite is flying forward, and opposite to that when the satellite is flying backwards (before and after the flip).

The solar panel is generally oriented as well as possible perpendicular to the sun-direction. The solar panel rotation axis is the satellite Y axis. However additional offsets from the nominal “to-sun” direction should be applied. These offsets are recorded in <ftp://ftp.ids-doris.org/pub/ids/satellites/topatt.txt> file.

7.3 MACROMODEL

The optical and infrared properties of the macro-model and the plate surfaces are given below.

// Surf(m ²)	// Normal in sat ref frame	// Optical properties			// Infrared properties		
		// spec	// diff	// abs	// spec	// diff	// abs
4.71	1. 0. 0.	0.2010	0.3750	0.4240	0.0810	0.1500	0.7690
4.71	-1. 0. 0.	0.2440	0.3860	0.3700	0.0020	0.0030	0.9950
8.18	0. 1. 0.	0.8860	0.3020	-0.1880	0.0950	0.0320	0.8730
8.18	0. -1. 0.	0.7820	0.3390	-0.1210	0.2000	0.0860	0.7140
8.32	0. 0. 1.	0.2390	0.3900	0.3710	0.0870	0.1430	0.7700
8.32	0. 0. -1.	0.2750	0.3630	0.3620	0.1090	0.1450	0.7460
// Solar array							
25.5	to sun	0.0500	0.2200	0.7300	0.0240	0.1060	0.8700
25.5	opposite to sun	0.1700	0.6600	0.1700	0.0250	0.0950	0.8800



7.4 DORIS PHASE CENTERS

Position of DORIS 2GHz Phase center in satellite reference frame:

```
X (m) // Y (m) // Z (m) //
0.092      1.092      1.182
```

Position of DORIS 400MHz phase center in satellite reference frame:

```
X (m) // Y (m) // Z (m) //
0.092      1.092      1.014
```

 <p>CNES CENTRE NATIONAL D'ÉTUDES SPATIALES</p>			<p>Réf. : SALP-NT-BORD-OP-16137-CN</p> <p>Ed. : 1/Rév. : 4</p> <p>Date : 14/06/2013</p> <p>Page : 15</p>
--------------------------------------------------------------------------------------------------------------------------------------	-----------------------------------------------------------------------------------	-----------------------------------------------------------------------------------	----------------------------------------------------------------------------------------------------------

8. JASON-1

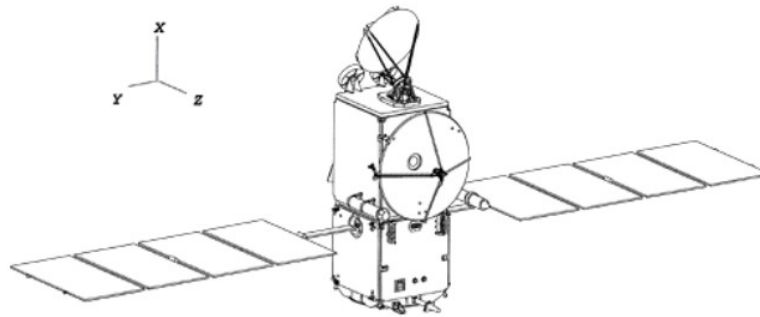

Figure 4 Jason-1 satellite

8.1 MASS AND CENTER OF GRAVITY

The origin of the satellite axes (Fig. 4) is at the launcher interface ring. Initial values of mass and center of gravity coordinates in satellite reference frame are

```
// Mass (kg) // X cog (m) // Y cog (m) // Z cog (m) //
489.1      0.955      0.      0.
```

The actual values of the satellite mass and CoG coordinates are obtained by adding the offsets available at <ftp://ftp.ids-doris.org/pub/ids/satellites/ja1mass.txt>

8.2 SATELLITE ATTITUDE AND SOLAR PANEL ORIENTATION

The nominal attitude law implemented in the ZOOM software and the orientation of the satellite reference frame is identical to that of TOPEX. In order to achieve a higher accuracy, quaternions obtained from star tracker data and solar panel orientation angles are available on CDDIS and IGN servers (ex: <ftp://cddis.gsfc.nasa.gov/pub/doris/ancillary/quaternions/ja1>, <ftp://doris.ensg.ign.fr/pub/doris/ancillary/quaternions/ja1>).

Differences between the Topex-like nominal attitude law and quaternions are discussed in ref. [6], as well as the differences between the nominal and true solar panel orientation angles.

8.3 MACROMODEL

The original macromodel for the Jason-1 satellite is available at <http://www.aviso.oceanobs.com/fr/calval/orbit/precise-orbit-determination-verification/index.html>.

This model was slightly modified by tuning the optical coefficients of the +/-Y faces and of the +X faces and by setting a scale factor equal to 0.97. This coefficient is meant to be a factor that multiplies the solar radiation pressure force. Details concerning how this model was originally

obtained, how it was later-on corrected and how it compares to the model from UCL are given in ref [6].

The coefficients of the updated model are given below

```

// Surf(m²) // Normal in sat ref frame // Optical properties // Infrared properties
// spec // diff // abs // spec // diff // abs
1.65 1. 0. 0. 0.0938 0.2811 0.2078 0.4250 0.1780 -.0260
1.65 -1. 0. 0. 0.4340 0.2150 0.0050 0.4080 0.1860 -.0120
3.0 0. 1. 0. 1.1880 -.0113 -.0113 0.3340 0.3420 0.2490
3.0 0. -1. 0. 1.2002 -.0044 -.0044 0.2740 0.3690 0.2970
3.1 0. 0. 1. 0.2400 0.4020 0.3300 0.2360 0.3820 0.3090
3.1 0. 0. -1. 0.3180 0.3700 0.2670 0.2980 0.3360 0.2400
// Solar array
9.8 1. 0. 0. 0.3440 0.0060 0.6470 0.0970 0.0980 0.8030
9.8 -1. 0. 0. 0.0040 0.2980 0.6970 0.0350 0.0350 0.9310

```

8.4 DORIS PHASE CENTERS

Position of DORIS 2GHz Phase center in satellite reference frame:

```

X (m) // Y (m) // Z (m) //
1.171 -0.598 1.027

```

Position of DORIS 400MHz phase center in satellite reference frame:

```

X (m) // Y (m) // Z (m) //
1.171 -0.598 0.859

```

9. JASON-2

The satellite is very similar to Jason-1 as both share the PROTEUS platform. The main differences are summarized in ref. [5], [6] and [7].

9.1 MASS AND CENTER OF GRAVITY



The origin of the satellite axes (Fig. 4) is at the launcher interface ring. Initial values of mass and center of gravity coordinates in satellite reference frame are

```

// Mass (kg) // X cog (m) // Y cog (m) // Z cog (m) //
505.9 0.9768 0.0001 0.0011

```

The actual values of the satellite mass and CoG coordinates are obtained by adding the offsets available at <ftp://ftp.ids-doris.org/pub/ids/satellites/ja2mass.txt>

			Réf. : SALP-NT-BORD-OP-16137-CN Ed. : 1/Rév. : 4 Date : 14/06/2013 Page : 17
-----------------------------------------------------------------------------------	-----------------------------------------------------------------------------------	-----------------------------------------------------------------------------------	---------------------------------------------------------------------------------------

9.2 SATELLITE ATTITUDE AND SOLAR PANEL ORIENTATION

The nominal attitude law and the orientation of the satellite reference frame is identical to that of Topex and Jason-1. Quaternions from star-trackers and solar panel orientation angles can be found at (ex: <ftp://cddis.gsfc.nasa.gov/pub/doris/ancillary/quaternions/ja1> , <ftp://doris.ensg.ign.fr/pub/doris/ancillary/quaternions/ja1>) .

Differences between the Topex-like nominal attitude law and quaternions are discussed in ref. [6], as well as the differences between the nominal and true solar panel orientation angles.

9.3 MACROMODEL

The macro-model is the same as that of Jason-1, the only difference being that the suggested scale factor for solar radiation pressure force is 1.0 and not 0.97.

9.4 DORIS PHASE CENTERS

Position of DORIS 2GHz Phase center in satellite reference frame:

```
X (m) // Y (m) // Z (m) //
1.194   -0.598   1.022
```

Position of DORIS 400MHz phase center in satellite reference frame:

```
X (m) // Y (m) // Z (m) //
1.194   -0.598   0.858
```

10. ENVISAT

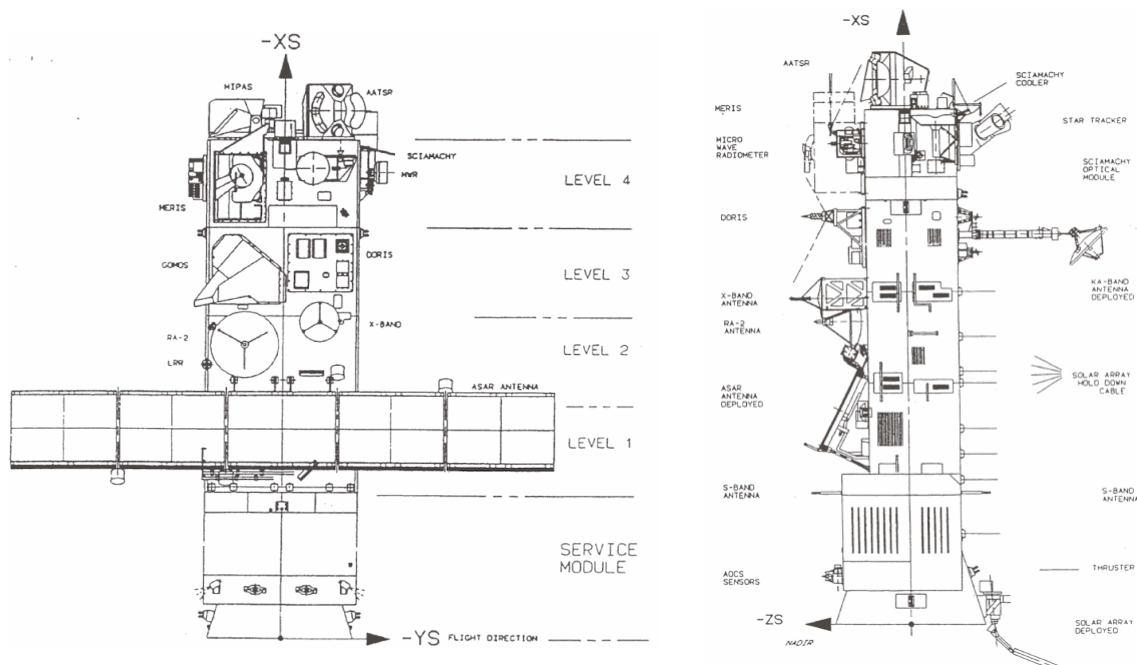

Figure 5 View of the Envisat satellite

10.1 MASS AND CENTER OF GRAVITY

Initial values of mass and center of gravity coordinates in satellite reference frame are

```
// Mass (kg) // X cog (m) // Y cog (m) // Z cog (m) //
8106.400      -4.365      -0.002      -0.039
```

The actual values of the satellite mass and CoG coordinates are obtained by adding the offsets available at <ftp://ftp.ids-doris.org/pub/ids/satellites/en1mass.txt>

10.2 SATELLITE ATTITUDE AND SOLAR PANEL ORIENTATION

The satellite Z axis is directed as the normal to the reference ellipsoid, pointing away from the Earth. The satellite X axis is approximately directed as the cross-track direction. The satellite Y axis is approximately directed as the opposite to the along-track direction. A small yaw-steering movement is performed to keep the satellite Y axis parallel to the ground-track (i.e. to the velocity in Earth fixed frame and not to the velocity in inertial frame). The amplitude of this yaw steering movement is roughly 4 degrees. Except for this yaw-steering movement and the pointing normal to the ellipsoid, the Envisat axis orientation is therefore identical to that that has been described for the SPOT family.

The following coefficients are needed to implement that guidance law : $CX = +0.1672$; $CY = +0.0501$; $CZ = +3.9130$; these coefficients, once transformed in radians, can be used to compute the yaw, roll, pitch angle in the following way

$$yaw = C_Z \cos(U_{lat}) \left[1 - \frac{(C_Z \cos U_{LAT})^2}{3} \right], pitch = C_X \sin(2U_{lat}), roll = C_Y \sin(U_{lat})$$

where U_{lat} is the “osculating true latitude” defined in ref. [2].

The rotation matrix that allows to transform the cross-track, – along-track, radial coordinates in body-fixed coordinates is

$$R_{N,-T,R \rightarrow body} = \begin{bmatrix} \cos(yaw) & \sin(yaw) & 0 \\ -\sin(yaw) & \cos(yaw) & 0 \\ 0 & 0 & 1 \end{bmatrix} \cdot \begin{bmatrix} 1 & 0 & 0 \\ 0 & \cos(pitch) & \sin(pitch) \\ 0 & -\sin(pitch) & \cos(pitch) \end{bmatrix} \cdot \begin{bmatrix} \cos(roll) & 0 & \sin(roll) \\ 0 & 1 & 0 \\ -\sin(roll) & 0 & \cos(roll) \end{bmatrix}$$

The solar panel is tilted of 22° from the rotation axis (X_{sat} , cross-track) as shown in figure 1 (same principle as the spot satellites). The rotation angle is chosen in order to be oriented as well as possible towards the sun.

10.3 MACROMODEL

The optical and infrared properties of the macro-model and the plate surfaces are given below. From the GDR-C standards (Apr. 2008) a tuned scale factor of 1.045 is applied to this model in CNES POE processing.

// Surf (m ²)	// Normal	in	sat	ref	frame	// Optical properties			// Infrared properties		
						// spec	// diff	// abs	// spec	// diff	// abs
15.64	1.	0.	0.			0.1770	0.4510	-0.0780	0.2500	0.0500	0.7000
15.64	-1.	0.	0.			0.0980	0.4340	0.0370	0.2500	0.0500	0.7000
22.92	0.	1.	0.			0.1460	0.4590	0.2040	0.2500	0.0500	0.7000
22.92	0.	-1.	0.			0.1460	0.4420	0.2220	0.2500	0.0500	0.7000
38.26	0.	0.	1.			0.1840	0.2640	0.4010	0.2500	0.0500	0.7000
38.26	0.	0.	-1.			0.1630	0.2740	0.4060	0.2500	0.0500	0.7000
// Solar array											
71.12	to sun					0.2080	0.0520	0.7400	0.1000	0.0600	0.8400
71.12	opposite to sun					0.1120	0.4480	0.4400	0.1000	0.0600	0.8400

10.4 DORIS PHASE CENTERS

Position of DORIS 2GHz Phase center in satellite reference frame:

X (m) // Y (m) // Z (m) //
 -7.052 -1.085 -1.725

Position of DORIS 400MHz phase center in satellite reference frame:

```
X (m) // Y (m) // Z (m) //
-7.052    -1.085    -1.560
```

11. CRYOSAT-2

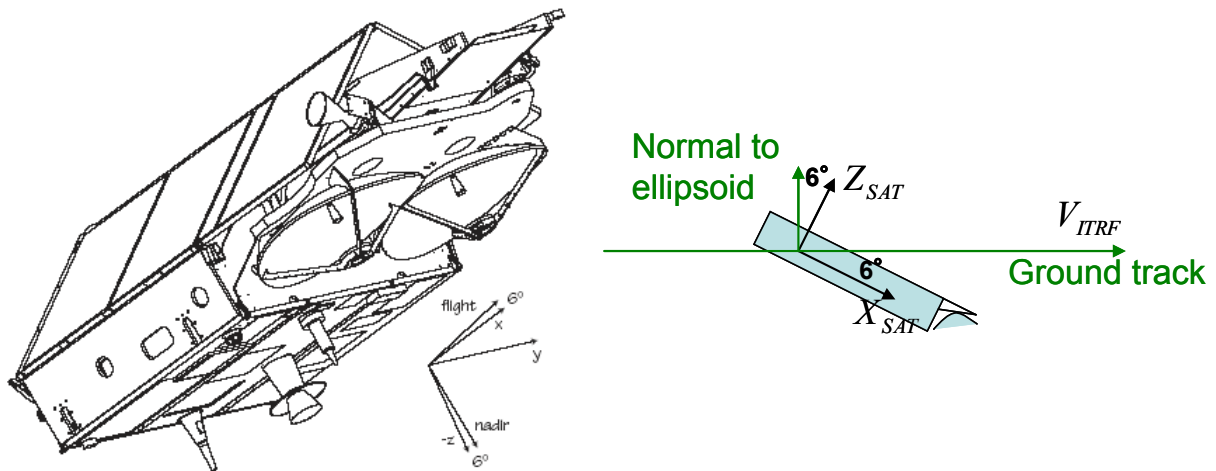

Figure 6 View of the Cryosat-2 satellite

11.1 MASS AND CENTER OF GRAVITY

Initial values of mass and center of gravity coordinates in satellite reference frame are

```
// Mass (kg) // X cog (m) // Y cog (m) // Z cog (m) //
724.6        1.6312    0.0112    0.0137
```

The actual values of the satellite mass and CoG coordinates are obtained by adding the offsets available at <ftp://ftp.ids-doris.org/pub/ids/satellites/cs2mass.txt>

```
// Days and seconds from Jan. 1, 1950 // Delta mass (kg) // X cog (m) // Y cog (m) // Z cog (m)
[ ... ]
22170 00000.000 -0001.369 -0000.000 -0000.000 +0000.000
22177 00000.000 -0001.375 -0000.000 -0000.000 +0000.000
22184 00000.000 -0001.381 -0000.000 -0000.000 +0000.000
22189 28800.000 -0001.431 -0000.000 -0000.000 +0000.000
22191 00000.000 -0001.447 -0000.000 -0000.000 +0000.000
22198 00000.000 -0001.453 -0000.000 -0000.000 +0000.000
22205 00034.000 -0001.459 -0000.000 -0000.000 +0000.000
22212 00034.000 -0001.465 -0000.000 -0000.000 +0000.000
22219 00034.000 -0001.474 -0000.000 -0000.000 +0000.000
[ ... ]
```

11.2 SATELLITE ATTITUDE AND SOLAR PANEL ORIENTATION

As shown in figure 6, the satellite is flying in a “nose-down” configuration. The satellite Z axis is tilted of 6 degrees with respect to the normal to the reference ellipsoid (pointing out from the Earth). The satellite X axis is oriented in order align the platform with the ground track, therefore there is a small yaw-steering of about 4 degrees (as for Envisat). The satellite X axis is inclined of 6 degrees with respect to the direction of velocity in the Earth fixed frame. The satellite Y axis is therefore pointing approximately towards the cross-track direction.

The solar panels are fixed with respect to the satellite.

11.3 MACROMODEL

The optical and infrared properties of the macro-model and the plate surfaces are given below.

11.3.1 ESA MACROMODEL

6 plates model, from ref. [3],

// Surf	// Normal in sat ref frame			// Optical properties			// Infrared properties		
				// spec	// diff	// abs	// spec	// diff	// abs
2.515	1.	0.	0.	0.0630	0.0930	0.8440	0.0230	0.1750	0.8020
2.515	-1.	0.	0.	0.0470	0.0960	0.8570	0.0150	0.1820	0.8030
5.114	0.	1.	0.	0.0480	0.0660	0.8870	0.0170	0.1240	0.8590
5.114	0.	-1.	0.	0.0400	0.0660	0.8940	0.0140	0.1270	0.8590
8.882	0.	0.	1.	0.0150	0.0560	0.9290	0.0050	0.1100	0.8850
8.882	0.	0.	-1.	0.1320	0.0850	0.7840	0.0540	0.1500	0.7960

11.3.2 CNES MACROMODEL

7 plates model, from ref. [3],

// Surf (m ²)	// Normal in sat ref frame			// Optical properties			// Infrared properties		
				// spec	// diff	// abs	// spec	// diff	// abs
2.4722	1.	0.	0.	0.2839	0.0000	0.7161	0.0230	0.1750	0.8020
2.4490	-1.	0.	0.	0.4980	0.0000	0.5020	0.0150	0.1820	0.8030
5.8445	0.	0.6112	0.7915	0.1796	0.0357	0.7846	0.0050	0.1100	0.8850
5.8445	0.	-0.6112	0.7915	0.1796	0.0357	0.7846	0.0050	0.1100	0.8850
2.2399	0.	0.9792	-0.2031	0.3299	0.2046	0.4655	0.0170	0.1240	0.8590
2.2399	0.	-0.9792	-0.2031	0.3299	0.2046	0.4655	0.0170	0.1240	0.8590
8.4229	0.	0.	-1.	0.3664	0.4764	0.1572	0.0540	0.1500	0.7960

11.4 DORIS PHASE CENTERS

Position of DORIS 2GHz Phase center in satellite reference frame:

X (m) // Y (m) // Z (m) //

1.848 -0.200 -0.751

Position of DORIS 400MHz phase center in satellite reference frame:

X (m) // Y (m) // Z (m) //

1.832 -0.200 -0.598

Note that the DORIS antenna axis is tilted of 6 degrees with respect to the satellite body fixed axes in order to be perpendicular to the reference ellipsoid; the components of the antenna axis unit vector in the satellite reference frame are therefore $X=0.1045$, $Y=0.0$, $Z = -0.9945$.

12. HY-2A

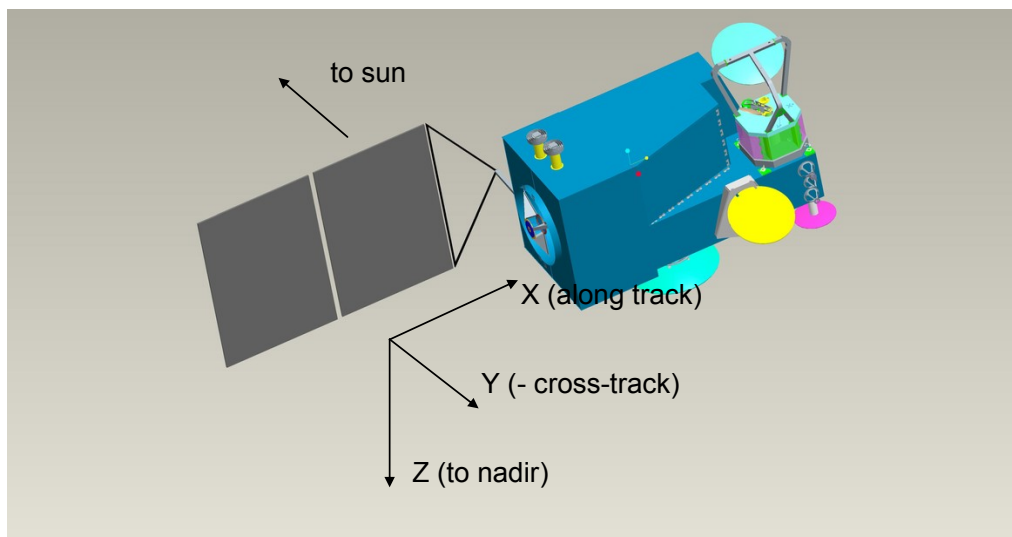

Figure 7 Schematic view of HY-2A satellite on the 14-day repeat cycle operational orbit

12.1 MASS AND CENTER OF GRAVITY

// Mass (kg) // X cog (m) // Y cog (m) // Z cog (m) //

1550.0 1.2464 0.0000 0.0008

The actual values of the satellite mass and CoG coordinates are obtained by adding the offsets available at <ftp://ftp.ids-doris.org/pub/ids/satellites/h2amass.txt>.

12.2 SATELLITE ATTITUDE AND SOLAR PANEL ORIENTATION

The current satellite attitude model adopted for the POE orbits assumes the satellite is flying with a fixed orientation with respect to the local orbital reference: the satellite X axis points toward the velocity, the Z axis opposite to the radial direction, the Y axis completes the reference, pointing opposite to the cross-track direction. The solar panel orientation is fixed with respect to the satellite, and points towards the sun.

12.3 MACROMODEL

The optical and infrared properties of the macro-model and the plate surfaces are given below.

// Surf (m ²)	// Normal in sat ref frame	// Optical properties			// Infrared properties			
		// spec	// diff	// abs	// spec	// diff	// abs	
3.21	1. 0. 0.	0.00	0.97	0.03	0.00	0.83	0.17	
3.52	-1. 0. 0.	0.00	0.97	0.03	0.00	0.86	0.14	
15.79	0. 1. 0.	0.00	0.45	0.55	0.00	0.41	0.59	
15.80	0. -1. 0.	0.00	0.64	0.36	0.00	0.52	0.48	
6.43	0. 0. 1.	0.00	0.96	0.04	0.00	0.82	0.18	
6.40	0. 0. -1.	0.00	0.96	0.04	0.00	0.78	0.22	

12.4 DORIS PHASE CENTERS

Position of DORIS 2GHz Phase center in satellite reference frame:

X (m) // Y (m) // Z (m) //

0.850 -0.750 1.306

Position of DORIS 400MHz phase center in satellite reference frame:

X (m) // Y (m) // Z (m) //

0.850 -0.750 1.144

13. SARAL

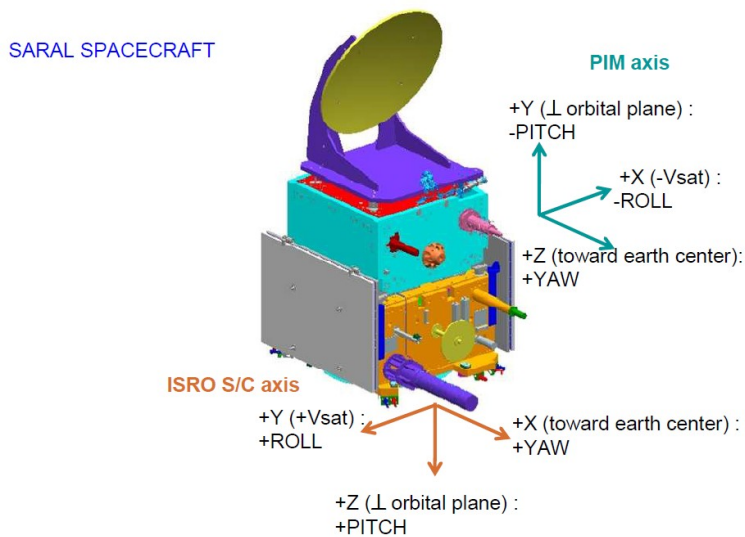

Figure 88 Schematic view of SARAL satellite

The following coordinates are given in the ISRO S/C axis reference frame, defined as in figure 8, where +X is nadir-pointed, +Z opposite to cross-track (opposite to orbit angular momentum), and +Y completes the orthonormal right-handed basis.

13.1 MASS AND CENTER OF GRAVITY

```
// Mass (kg) // X cog (m) // Y cog (m) // Z cog (m) //
408.60      -0.0113      -0.0067      -0.6583
```

The actual values of the satellite mass and CoG coordinates are obtained by adding the offsets Available at <ftp://ftp.ids-doris.org/pub/ids/satellites/srlmass.txt> Satellite total mass (after Orbit Acquisition maneuvers and the 2 first Station Keeping maneuvers – April 13th 2013) = +404.916 kg .

13.2 SATELLITE ATTITUDE AND SOLAR PANEL ORIENTATION

The current satellite attitude model adopted for the POE orbits assumes the satellite is flying with a fixed orientation with respect to the local orbital reference: +X is nadir-pointed, +Z opposite to cross-track (opposite to orbit angular momentum), and +Y completes the orthonormal right-handed basis. The solar panel orientation is fixed with respect to the satellite, and points towards the sun.

13.3 MACROMODEL

The optical and infrared properties of the macro-model and the plate surfaces are given below.

// Surf (m ²)	// Optical properties				// Infrared properties					
	// Normal in sat ref frame				// spec	// diff	// abs	// spec	// diff	// abs
2.353	1.	0.	0.	0.4000	0.2450	0.3550	0.2500	0.7500	0.0000	
2.353	-1.	0.	0.	0.5450	0.1690	0.2860	0.2500	0.7500	0.0000	
2.177	0.	1.	0.	0.5170	0.1720	0.3040	0.2500	0.7500	0.0000	
2.177	0.	-1.	0.	0.5200	0.1840	0.3020	0.2500	0.7500	0.0000	
5.488	0.	0.	1.	0.2940	0.0760	0.6230	0.2500	0.7500	0.0000	
5.488	0.	0.	-1.	0.0780	0.0760	0.8370	0.2500	0.7500	0.0000	

13.4 DORIS PHASE CENTERS

Position of DORIS 2GHz Phase center in satellite reference frame:

```
X (m) // Y (m) // Z (m) //
0.805      -0.304      -1.129
```

Position of DORIS 400MHz phase center in satellite reference frame:

```
X (m) // Y (m) // Z (m) //
0.647      -0.304      -1.129
```

14. APPENDIX 1 - EXAMPLE OF COMPUTATION OF THE SOLAR RADIATION PRESSURE

For validation purposes, we compute here the acceleration of the SPOT-5 main body, solar panel excluded, according to the optical coefficients and surface geometry given previously, according to the formula

$$\vec{a} = \sum_{i=1}^6 A_i (\vec{u} \cdot \vec{n}_i) \left[2K_{vis,i}^s (\vec{u} \cdot \vec{n}_i) \vec{n}_i + K_{vis,i}^d \left(\vec{u} - \frac{2}{3} \vec{n}_i \right) + K_{vis,i}^a \vec{u} \right]$$

where

- $K_{vis,i}^s$, $K_{vis,i}^d$, $K_{vis,i}^a$ are the coefficients for the specular, diffused and absorbed portions of the received power in the visible spectrum presented for surface element i (table below)
- A_i, \vec{n}_i are respectively the area of each surface element
- \vec{u} is the direction of the incident flux, positive from source to satellite. // Optical properties

// Surf (m ²)	// Normal	in sat ref frame	// spec	// diff	// abs
7.21	1.	0.	0.3460	0.2610	-0.108
7.21	-1.	0.	0.1610	0.0510	0.3940
10.79	0.	-1.	0.4750	0.3680	0.0470
10.79	0.	1.	0.4570	0.3660	0.0710
11.79	0.	0.	1.	0.3700	0.2010
11.79	0.	0.	-1.	0.3930	0.2620

The resulting acceleration is given below. The spherical coordinates (azim, elevation), once

translated in radians, directly provide the direction of the incident flux: $\vec{u} = - \begin{cases} \cos(el.) \cos(az.) \\ \cos(el.) \sin(az.) \\ \sin(el.) \end{cases}$.

```
//Result: (acceleration per unit surface)
//sun azim (°)// sun elevation (°) // ax (m2) // ay (m2) // az (m2)
0.0 -90.0 -0.000 0.000 17.245
0.0 -45.0 -6.893 0.000 9.600
0.0 0.0 -7.347 0.000 0.000
0.0 45.0 -7.128 0.000 -9.226
0.0 90.0 -0.000 0.000 -16.695
45.0 -90.0 -0.000 -0.000 17.245
45.0 -45.0 -5.422 -7.329 11.106
45.0 0.0 -6.291 -9.702 0.000
45.0 45.0 -5.588 -7.496 -10.732
45.0 90.0 -0.000 -0.000 -16.695
90.0 -90.0 -0.000 -0.000 17.245
90.0 -45.0 -0.000 -12.110 11.407
```



90.0	0.0	-0.000	-17.210	0.000
90.0	45.0	-0.000	-12.345	-11.032
90.0	90.0	-0.000	-0.000	-16.695
135.0	-90.0	0.000	-0.000	17.245
135.0	-45.0	4.776	-7.855	11.850
135.0	0.0	5.296	-10.755	0.000
135.0	45.0	4.943	-8.022	-11.476
135.0	90.0	0.000	-0.000	-16.695
180.0	-90.0	0.000	-0.000	17.245
180.0	-45.0	5.898	-0.000	10.653
180.0	0.0	5.775	-0.000	0.000
180.0	45.0	6.133	-0.000	-10.279
180.0	90.0	0.000	-0.000	-16.695
225.0	-90.0	0.000	0.000	17.245
225.0	-45.0	4.717	7.900	11.766
225.0	0.0	5.177	10.840	0.000
225.0	45.0	4.884	8.067	-11.392
225.0	90.0	0.000	0.000	-16.695
270.0	-90.0	0.000	0.000	17.245
270.0	-45.0	0.000	12.195	11.288
270.0	0.0	0.000	17.375	0.000
270.0	45.0	0.000	12.431	-10.913
270.0	90.0	0.000	0.000	-16.695
315.0	-90.0	-0.000	0.000	17.245
315.0	-45.0	-5.362	7.374	11.022
315.0	0.0	-6.172	9.788	0.000
315.0	45.0	-5.529	7.541	-10.648
315.0	90.0	-0.000	0.000	-16.695

In order to obtain the modelled solar radiation pressure acceleration, the above numbers have to be multiplied by $\frac{1}{M} \frac{W}{c}$, where M is the satellite mass and $\frac{W}{c}$ the received power at visible wavelength divided by the speed of light. This is obtained by modulating the solar constant at 1 AU, by the ratio $(1 \text{ AU} / \text{true sun-satellite distance})^2$, which depends on the current epoch.

The following table shows the main body and solar panel contribution to the direct solar radiation pressure over 1 orbital revolution computed by the ZOOM software using the SPOT-5 macromodel.

//TAI time	Main Body contribution (1e-9 m/s ²)			Solar Panel contribution (1e-9 m/s ²)		
//yr, mo, day, sec //	ax	ay	az	ax	ay	az
2010 10 07 75360	-4.4915	-24.3700	-1.2939	-9.4396	-28.2547	-7.7491
2010 10 07 75660	-4.6669	-24.3746	2.6129	-9.4380	-29.2736	1.2051
2010 10 07 75960	-5.2206	-21.7638	8.9394	-9.3475	-27.2619	9.9519
2010 10 07 76260	-0.0000	-0.0000	0.0000	-0.0000	-0.0000	0.0000
2010 10 07 76560	-0.0000	-0.0000	0.0000	-0.0000	-0.0000	0.0000
2010 10 07 76860	-0.0000	-0.0000	0.0000	-0.0000	-0.0000	0.0000
2010 10 07 77160	-0.0000	0.0000	0.0000	-0.0000	0.0000	0.0000
2010 10 07 77460	-0.0000	0.0000	0.0000	-0.0000	0.0000	0.0000
2010 10 07 77760	-0.0000	0.0000	0.0000	-0.0000	0.0000	0.0000
2010 10 07 78060	-5.1186	22.5863	8.1425	-9.4392	23.7732	17.1170
2010 10 07 78360	-4.4675	24.5942	2.0129	-9.4392	27.8678	9.0428
2010 10 07 78660	-4.4738	24.6790	-1.7423	-9.4384	29.2998	0.1026
2010 10 07 78960	-5.2035	22.9835	-7.5730	-9.4378	27.9338	-8.8476
2010 10 07 79260	-5.6083	17.4453	-14.6725	-9.4377	23.9013	-16.9517
2010 10 07 79560	-5.6501	9.9184	-20.5897	-9.4384	17.5899	-23.4359
2010 10 07 79860	-5.3252	2.9132	-23.2670	-9.4395	9.6053	-27.6831
2010 10 07 80160	-5.2524	-1.9556	-23.3525	-9.4407	0.7117	-29.2927
2010 10 07 80460	-5.6730	-8.5831	-21.4312	-9.4416	-8.2428	-28.1171
2010 10 07 80760	-5.7252	-16.1217	-15.9935	-9.4417	-16.4083	-24.2743
2010 10 07 81060	-5.4046	-22.0818	-8.9261	-9.4411	-23.0137	-18.1338



Réf. : SALP-NT-BORD-OP-16137-CN

Ed. : 1/Rév. : 4

Date : 14/06/2013

Page : 27

15. APPENDIX 2 - ESTIMATED EMPIRICAL FORCES

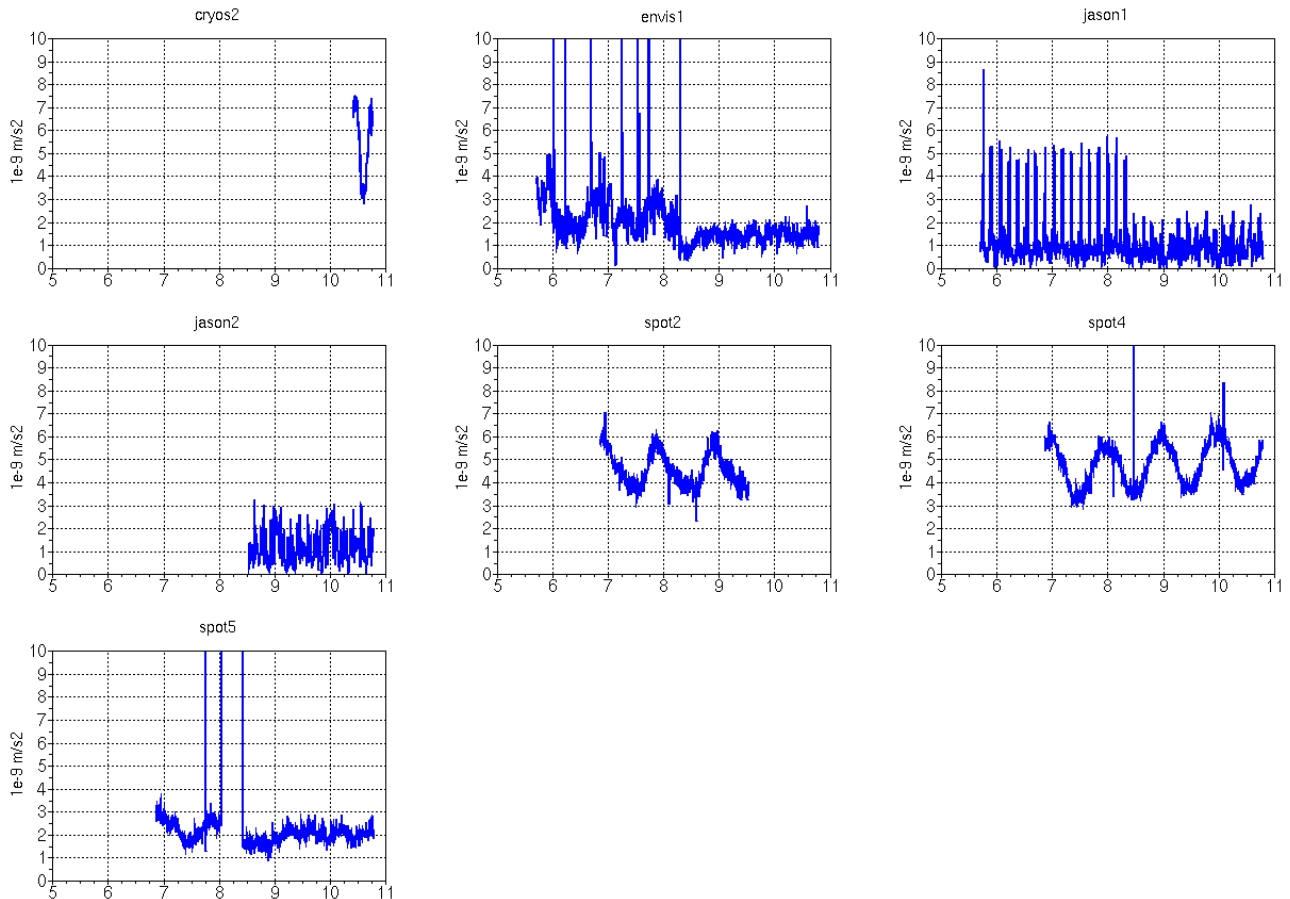

Figure 99 Amplitude of the 1/rev along-track empirical forces estimated during the DORIS-only POE processing using the previously described models ; Cryosat-2 POE orbit is obtained using the ESA model, which exhibits a large error at beta-prime period; Envisat: the model described in the previous section has been tuned with a 1.045 scale factor when we moved to GDR-C standards in 2008; Jason-1 / Jason-2: the GDR-C tuned model removes the large spikes in fixed yaw; Spot 2, Spot4: these are very simplified models that exhibit the highest error among CNES models; Spot-5: for few months the offset applied to the solar array has not been applied in the standard POE processing, which explains the jump at the beginning of 2008.