



Reference : CO-SP-D0-OP-14815-CN
 Issue : 4.2
 Date : 15/06/05
 Page : 1/34

DORIS

MODELLING OF DORIS 2GM AND CRYOSAT INSTRUMENTS

Written by:

P. SENGENES

C. JAYLES

Date and Signature

20/06/2005

Authorized by :

J. NOUBEL

Date and Signature

For approval:

S. COUTIN - FAYE

A. AURIOL

Date and Signature

For application to	DS2	TP	DS4	DPP	DJ1	DS5	DH2	DJ2	DCY	D3S		SMM
					X	X			X			X
Models												

Configuration-managed document

YES

by: CCM DORIS

As of : 24/04/03

Document status:



Reference : CO-SP-D0-OP-14815-CN
 Issue : 4.2
 Date : 15/06/05
 Page : 2/34

Title : MODELLING OF DORIS 2GM AND CRYOSAT INSTRUMENTS

INDEXING SHEET

Confidentiality:	YES/NO	Type:
Key words:		
Software used :	Number of extra pages:	
Author's summary:		

CHANGES

Changes with respect to the previous version are indicated by a vertical line in the left-hand margin.

Revision	Date	Purpose
0.0	24/04/03	Creation of document.
1.0	04/05/03	Incorporation of the DM CO-D0-354-CN (page 18)
2.0	25/05/04	Incorporation of the DM CO-0-348-CN
3.0	17/09/04	English translation : replace french version
4.0	07/12/04	Incorporation of the DM CO-D0-388-CN
4.1	14/02/05	Incorporation of the DM CO-D0-405-CN p.23
4.2	15/06/05	Incorporation of the DM CO-D0-407 rev.1 p.29, p.30

APPLICABLE DOCUMENTS AND REFERENCE DOCUMENTS

Reference	Title of document
CO-SP-0-OP-2460-CN	DA1. MODELLING OF DORIS INSTRUMENTS
CO-IF-D1/B-EA-10823-CN	DA2. INTERFACE SPECIFICATIONS BETWEEN THE DORIS NETWORK BEACONS AND THE ONBOARD INSTRUMENT
DS2/DD/10/5	DR1. DOSSIER DE DÉFINITION DE L'INSTRUMENTATION (CHAPITRE : BILAN DES PERFORMANCES) ED. 2 EDITION PROVISOIRE [INSTRUMENT DEFINITION FILE (SECTION : REPORT ON PERFORMANCES) SECOND DRAFT ISSUE]
CO-IF-D1/M-EA-10960-CN	DR2. SPÉCIFICATION D'INTERFACES ENTRE LES CENTRES DE CONTRÔLE DORIS ET LES INSTRUMENTS DORIS/SPOT5 ET DORIS/H2 [SPECIFICATION OF INTERFACES BETWEEN THE DORIS CONTROL CENTRES AND THE DORIS/SPOT 5 AND DORIS/H2 INSTRUMENTS]
DJ1-RP-D11-IE-11926-ESD	DR3. CRE DES MVR FM2 ET FM23 DORIS/JASON [TEST REVIEW BOARD FOR DORIS/JASON MVR INSTRUMENTS, FM2 AND FM3]
DJ1-RP-D13-IE-11929-SR	DR4. ANTENNE DORIS – RAPPORT D'ESSAIS D'ACCEPTATION DU MODELE MV6 [DORIS ANTENNA – ACCEPTANCE TEST REPORTS FOR FM6]
DS5-RP-D11-IE-12355-CN	DR5. CRE MVR SPOT5 [TEST REVIEW BOARD FOR SPOT 5 MVR]
DS5-RP-D13-EA-12367-SR	DR6. ANTENNE DORIS – RCI DU MODÈLE DE VOL MV9 [DORIS ANTENNA – EIDP FOR FM9]
89/112-RA/TE/AE/IT/TF	DR7. CALIBRATION ET SUIVI HORAIRE DE LA BALISE MAÎTRESSE DE TOULOUSE DU 25/10/89 [CALIBRATION AND TIME MONITORING OF THE TOULOUSE MASTER BEACON ON 25/10/89]
CM-RP-121-2985-SR	DR8. ANTENNES POUR BALISES DE LOCALISATION DORIS TYPE 52290 [ANTENNAS FOR DORIS TYPE 52290 LOCATION BEACONS]
89/CT/DTI/MS/MO/164	DR9. LA FONCTION DE MESURE DATATION DORIS DANS ZOOM : DESCRIPTION [DORIS TIME-TAGGING MEASUREMENT FUNCTION IN ZOOM SOFTWARE PACKAGE : DESCRIPTION]
CM-NT-D13-EA-9916-SR	DR10. FAX STAREC DU 05/02/93 CENTRES DE PHASE ANTENNES BORD DORIS [STAREC FAX OF 5/02/83. DORIS ONBOARD ANTENNAS PHASE CENTRES]

This document is CNES property. Information in it may not be communicated, published or reproduced without prior approval from CNES.



Reference : CO-SP-D0-OP-14815-CN
Issue : 4.2
Date : 15/06/05
Page : 3/34

Title : MODELLING OF DORIS 2GM AND CRYOSAT INSTRUMENTS

TP2-NT-J0-382-CNES	DR11. MISSION ANALYSIS FOR JASON
S5-ST-0-10-CN	DR12. SPECIFICATION SYSTEME SPOT5 [SYSTEM SPECIFICATION FOR SPOT5]
DCY-RP-D13-IE-15029-SR	DR13. ANTENNE DORIS – RAPPORT D'ESSAIS D'ACCEPTATION DU MODELE MV13 [DORIS ANTENNA – ACCEPTANCE TESTE REPORTS FOR FM13 MODEL]
CS-TN-ESA-SY-0nnn	DR14. CRYOSAT – PRECISE ORBIT CONTEXT

LIST OF TBC AND TBD

TBC/TBD	Paragraph	Brief title
TBD	5.3.1	Model f_b (current, voltage, etc...)



Reference : CO-SP-D0-OP-14815-CN

Issue : 4.2

Date : 15/06/05

Page : 4/34

Title : MODELLING OF DORIS 2GM AND CRYOSAT INSTRUMENTS

ABBREVIATIONS

Acronym	Definition
BIH	Bureau International de l'Heure [International Time Bureau]
BM	Balise Maître [Master Beacon]
BMK	Balise Maître de Kourou [Kourou Master Beacon]
BMT	Balise Maître de Toulouse [Toulouse Master Beacon]
CTD	TC de correction de temps directe (décalage du séquençement) [Direct time correction TC (shift in sequencing)]
GECO	Groupe d'Exploitation et Coordination des Opérations [Operation Control and Coordination Group]
MVR	Mesure de Vitesse Radiale [Radial Velocity Measurement]
RAZ	TC de remise à zéro de l'heure bord et du séquençement [TC for reset to zero of onboard time and sequencing]
SL	Satellite
TAB	Temps Atomique Balise maître. Selon qu'il s'agit de celle de Toulouse ou de Kourou TAB = TAC ou TAK respectivement [Master Beacon Atomic Time, depending on whether it is from Toulouse or Kourou TAB = TAC or TAK respectively]
TAC	Temps Atomique CNES (horloge du laboratoire TF qui pilote la BMT) [CNES Atomic Time (TF laboratory clock which drives the Toulouse Master Beacon)]
TAI	Temps Atomique International [International Atomic Time]
TAK	Temps Atomique Kourou (horloge Césium de la BMK) [Kourou Atomic Time (Caesium clock of the Kourou Master Beacon)]
TCMD	Top de Comptage de la Mesures Distance [Counting time pulse for Range measurements]
TM	TéléMesure [Telemetry]
TOUS	Heure bord DORIS [DORIS Onboard Time]



Reference : CO-SP-D0-OP-14815-CN
Issue : 4.2
Date : 15/06/05
Page : 5/34

Title : MODELLING OF DORIS 2GM AND CRYOSAT INSTRUMENTS

CONTENTS

1. SCOPE	6
2. APPLICABILITY	6
3. CONVENTIONS	7
4. DESCRIPTION OF MEASUREMENT TYPES	8
4.1 PHASE MEASUREMENT PRINCIPLE	8
4.2 MODELLING OF THE DORIS 2GM PHASE MEASUREMENT	10
4.2.1 BACKGROUND INFORMATION ON TIME BASES	10
4.2.2 DORIS 2GM MEASUREMENT FUNCTION.....	12
4.3 PSEUDO-RANGE MEASUREMENT PRINCIPLE	15
4.4 MODELING OF THE PSEUDO-RANGE MEASUREMENT	16
5. MODELS	17
5.1 GROUND	17
5.2 PROPAGATION (T_P)	17
5.3 ONBOARD INSTRUMENTS	17
5.3.1 ONBOARD USO FREQUENCY	17
5.3.2 MVR INSTRUMENT (<i>MESUREUR DE VITESSE RADIALE</i>).....	18
5.3.3 ONBOARD ANTENNAS.....	21
5.3.4 LOSSES DUE TO ONBOARD CABLES.....	24
5.3.5 PLATFORM GEOMETRY.....	25

ANNEX 1 : DEPLOYED CONFIGURATION OF THE JASON-1 SATELLITE

ANNEX 2 : CRYOSAT SATELLITE REFERENCE FRAME



Reference : CO-SP-D0-OP-14815-CN
Issue : 4.2
Date : 15/06/05
Page : 6/34

Title : MODELLING OF DORIS 2GM AND CRYOSAT INSTRUMENTS

1. SCOPE

This document lists the modelling parameters for DORIS 2GM DORIS/CRYOSAT instruments (beacons and onboard instruments) used for DORIS measurements ground processing.

It also proposes a '2GM/CRYOSAT measurements function'.

The model is based on a compilation of definition documents and test results listed in references as well as observations during operations.

NB: This document does not describe instrument performances.

2. APPLICABILITY

This document applies to the DORIS/JASON-1 and DORIS/SPOT5 projects in operation and to DORIS/CRYOSAT during its development and operation phases, particularly with respect to the ground segments which process data from these projects.

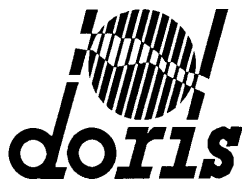

Reference : CO-SP-D0-OP-14815-CN
 Issue : 4.2
 Date : 15/06/05
 Page : 7/34

Title : MODELLING OF DORIS 2GM AND CRYOSAT INSTRUMENTS

3. CONVENTIONS

The notations are defined below and indexed as follows:

Index 0: nominal values; the index is completed if necessary by the channel concerned (400 MHz or 2 GHz) when the values are different.

NOTATIONS

f_s	ground USO frequency (f_{s0} = nominal frequency = 5 MHz)
H	multiplying coefficient for beacon USO frequency ($H_{400\text{MHz}} = 80.25$, $H_{2\text{GHz}} = 407.25$ for non-shifted frequency beacons, see section.4.2.2.1 for the general case)
τ_s	beacon and ground antenna electronic delays
f_e	frequency emitted (antenna output)
εf_e	noise on frequency emitted
T_p	propagation time between the phase centre of the ground antenna and the onboard counter
T_e	geometric propagation time
τ_e	propagation errors (ionosphere, troposphere, antenna patterns)
$f_r, \varepsilon f_r$	frequency received and noise on f_r (antenna input)
τ_{m1}, τ_{m2}	onboard MVR and antenna electronic delay in Doppler channel at beginning and end of counting
f_b	onboard USO frequency (f_{b0} = nominal frequency = 10 MHz)
K	multiplier of f_b giving onboard reference frequency ($K_{400\text{MHz}} = 40.125$, $K_{2\text{GHz}} = 203.625$)
k	(also called 'k factor'): parameter used for calculating a beacon's emission frequency
RAZ, CTD	TD_i resynchronisation
TD_i	10 s time pulse for onboard sequencing
S_i	10 s time pulse for beacon sequencing
T10	integer 10s TAI pulses
t10	integer 10s TAC pulses
ε_{TF}	difference between TAC and TAI
τ_{Si}	delay between beacon S_i and TAC (delay on lines and beacon input electronics)
τ_{s3}	ground beacon and antenna electronics delay affecting the time-tagging bit
τ_{m3}	onboard MVR and antenna electronics delay affecting the time-tagging bit
T3	onboard time-tagged event (arrival of time-tagging bit at counter input)
IT3	'time-tagging' = number of $f_b/K5$ frequency cycles between TD_i and T3
DATE_TOUS	' TD_i onboard time' = time in the onboard time base between RAZ and the given TD_i
$T_{p3}, T_{e3}, \tau_{e3}$	ditto T_p, T_e, τ_e but for the time-tagging bit

NB: T10, t10, S_i , T3, TD_i , RAZ and CTD are **events** which can be tagged in TAI or onboard time or other time scales.

Example: TAI (T3) or TOUS (T3) or TAC (TD_i).

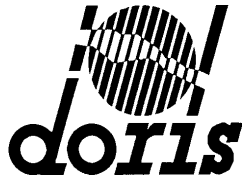

4. DESCRIPTION OF MEASUREMENT TYPES

There are two types of measurements :

- Phase measurements (sections 4.1 and 4.2),
- Pseudo-range measurements (sections 4.3 and 4.4) which are used to determine and control ground/onboard synchronisation.

4.1 PHASE MEASUREMENT PRINCIPLE

On the receiver, the instrument counts the number of cycles received in base band on the RF '400 MHz' and '2 GHz' channels, between two events, E1 = beginning of counting, and E2 = end of counting.

In the most general case, the receiver records the phase values according to the following time diagram:

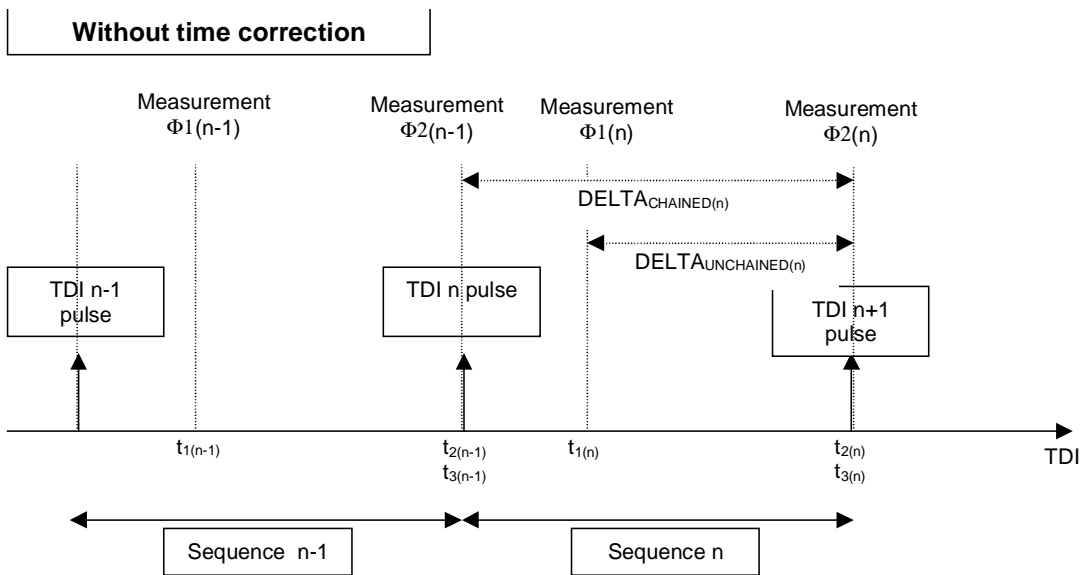

In this case, the measurement (of the phase differences) N2 recorded for the Tdi sequence n is :

⇒ If the measurement **is not chained** to the previous measurement:

$$N2 = \Delta_{UNCHAINED(n)} = \phi_2(n) - \phi_1(n)$$

In this case, E1 refers to the 'recording of the $\phi_1(n)$ phase" event, and E2 refers to the, 'recording of the $\phi_2(n)$ phase" event. The delay between E1 and E2, called the counting time, is exactly 7 TOUS seconds.

⇒ If the measurement **is chained** to the previous one:

$$N2 = \text{DELTA}_{\text{CHAINED}}(n) = \phi_2(n) - \phi_2(n-1)$$

In this case, E1 refers to the, 'recording of the $\phi_2(n-1)$ phase" event, and E2 refers to the 'recording of phase $\phi_2(n)$ ' event. The delay between E1 and E2 is exactly 10 TOUS seconds.

In the specific case in which a time correction is triggered, the time diagram is slightly different:

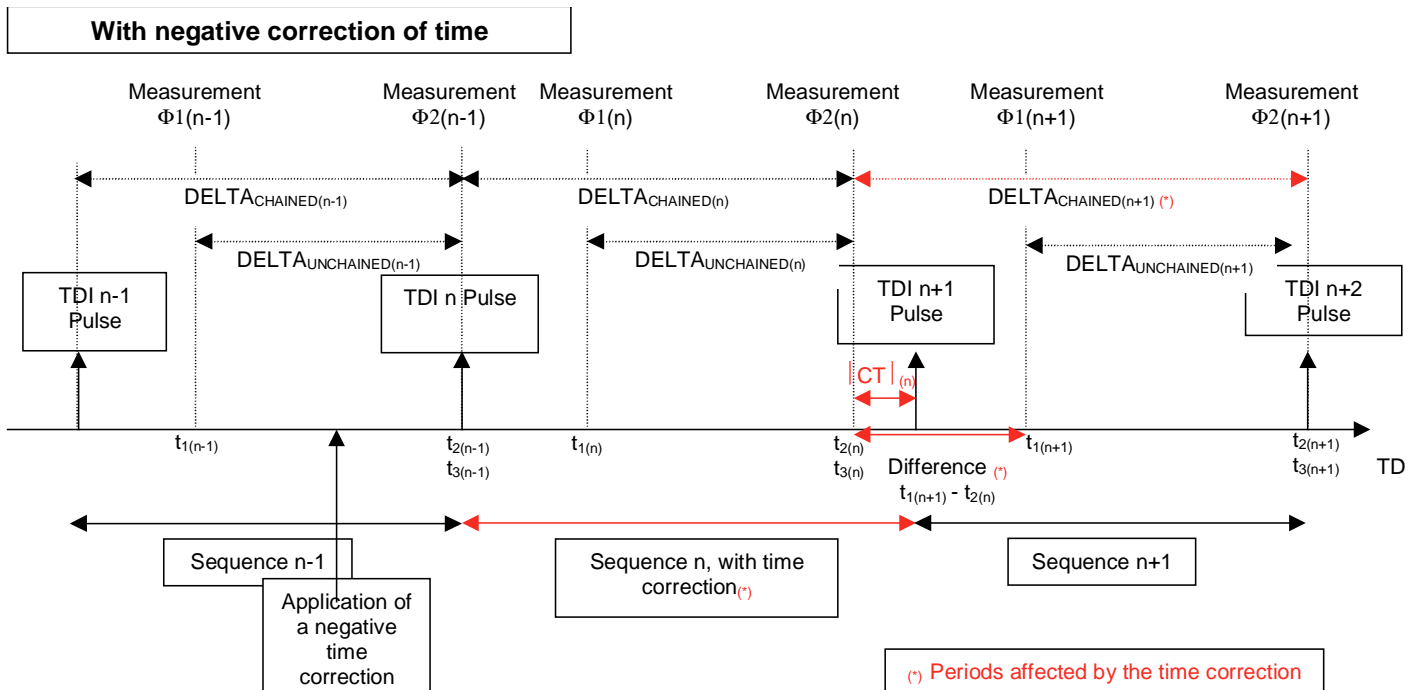

As we can see, only the N2 measurement recorded during the Tdi n+1 sequence, has a different time diagram to the other measurements if this measurement **is chained** to the previous one:

$$N2 = \text{DELTA}_{\text{chained}}(n+1) = \phi_2(n+1) - \phi_2(n)$$

Except that this time, the $\phi_2(n)$ phase was not recorded at the moment of the Tdi n+1 Time signal, but slightly before:

The time of the beginning of counting (in other words, the time of event E1) is 0 TOUS seconds **LESS the absolute value of the time correction**.

The delay between E1 and E2 is exactly 10 TOUS seconds **PLUS the absolute value of the time correction**.

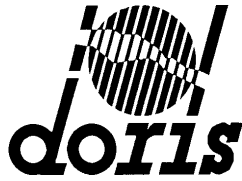

Reference : CO-SP-D0-OP-14815-CN
 Issue : 4.2
 Date : 15/06/05
 Page : 10/34

Title : MODELLING OF DORIS 2GM AND CRYOSAT INSTRUMENTS

It should be noted that if the measurement is not chained to the previous one, the delay between E1 and E2 is exactly 7 TOUS seconds and the counting time is thus not affected by a time correction.

4.2 MODELLING OF THE DORIS 2GM PHASE MEASUREMENT

The following section describes the DORIS 2GM measuring phase (or integrated Doppler).

4.2.1 BACKGROUND INFORMATION ON TIME BASES

Time Bases (or BDT) refers to equipment (USO, OCXO, atomic clock, MASER, etc.) which provides a periodical reference signal, with frequency $F(t)$ at time t , in TAI, whose nominal value is F_{nom} .

Let us consider two events E1 and E2 : their TAI times are written $TAI(E1)$ and $TAI(E2)$.

The frequencies are measured in 'TAI Hertz' (the inverse unit for the TAI second).

4.2.1.1 DURATION EXPRESSED IN THE TIME BASE

One second in the time base is the time necessary for counting F_{nom} periods for the periodical reference signal.

The number of periods of the reference signal for the time base, counted between E1 and E2, divided by F_{nom} is referred to as the duration (in the time base BDT) between the events [E1,E2] in BDT seconds (written $BDT(E1,E2)$).

4.2.1.2 DURATION EXPRESSED IN TAI

The duration measured in international atomic time (TAI) between the two events E1 and E2 is written $TAI(E1,E2)$. It is the number of seconds counted on a virtual reference signal representing the TAI time. We still have :

$$TAI(E1,E2)=TAI(E2)-TAI(E1)$$

4.2.1.3 RELATIONSHIP BETWEEN DURATION (TIME BASE) and DURATION (TAI)

The number of periods counted in the reference signal between E1 and E2 is by definition equal to:

$$\int_{TAI(E1)}^{TAI(E2)} F(t) dt$$

Let $\delta F(t) = F(t) - F_{nom}$

$$\text{Then : } BDT(E1,E2) = \int_{TAI(E1)}^{TAI(E2)} \frac{F(t)}{F_{nom}} dt = \int_{TAI(E1)}^{TAI(E2)} \frac{\delta F(t)}{F_{nom}} dt + (TAI(E2) - TAI(E1))$$

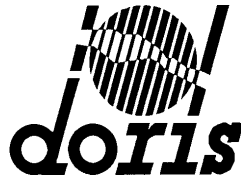

Reference : CO-SP-D0-OP-14815-CN
 Issue : 4.2
 Date : 15/06/05
 Page : 11/34

Title : MODELLING OF DORIS 2GM AND CRYOSAT INSTRUMENTS

Let $\frac{\overline{\delta F(E1, E2)}}{F_{nom}}$ be the mean value of $\delta F(t)/F_{nom}$ between E1 and E2, then (by definition of the mean value):

$$\frac{\overline{\delta F(E1, E2)}}{F_{nom}} = \frac{1}{(TAI(E2) - TAI(E1))} \int_{TAI(E1)}^{TAI(E2)} \frac{\delta F(t)}{F_{nom}} dt \quad [A]$$

This then gives the relationship between a BDT duration and a TAI duration:

$$BDT(E1, E2) = TAI(E1, E2) * \left(1 + \frac{\overline{\delta F(E1, E2)}}{F_{nom}} \right) \quad [B]$$

4.2.1.4 NUMBER OF CYCLES

The frequency with which the count is performed, is generated by multiplying the reference frequency of the time base equipment by a multiplying coefficient K.

Let $F_{theo} = K * F_{nom}$ (K is intentionally constant by construction).

$$F_{true}(t) = K * F(t) = \left(\frac{F_{theo}}{F_{nom}} \right) * (\delta F(t) + F_{nom}) = F_{theo} * \left(1 + \frac{\delta F(t)}{F_{nom}} \right)$$

The number of cycles generated between E1 and E2 is:

$$NCY(E1, E2) = \int_{TAI(E1)}^{TAI(E2)} F_{true}(t) dt = F_{theo} * \int_{TAI(E1)}^{TAI(E2)} \left(1 + \frac{\delta F(t)}{F_{nom}} \right) dt$$

hence, following [A] :

$$NCY(E1, E2) = F_{theo} * (TAI(E2) - TAI(E1)) * \left(1 + \frac{\overline{\delta F(E1, E2)}}{F_{nom}} \right) \quad [C]$$

The average frequency between E1 and E2 is thus:

$$\overline{F_{true}(t)} = \frac{NCY(E1, E2)}{TAI(E2) - TAI(E1)} = F_{theo} * \left(1 + \frac{\overline{\delta F(E1, E2)}}{F_{nom}} \right)$$

Comment : $NCY(E1, E2)$ can be thus expressed directly in the time base by using [B] and [C]:

$$NCY(E1, E2) = F_{theo} * BDT(E1, E2) \quad [D]$$

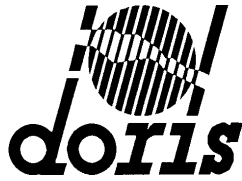

Reference : CO-SP-D0-OP-14815-CN
Issue : 4.2
Date : 15/06/05
Page : 12/34

Title : MODELLING OF DORIS 2GM AND CRYOSAT INSTRUMENTS

4.2.2 DORIS 2GM MEASUREMENT FUNCTION

To simplify the description, this section will not go into the distinction between the 400 MHz and 2 GHz channels. The following comments are valid for both measurement channels.

On each of the two measurement channels, the number of cycles (between two events E1 = beginning of counting, and E2 = end of counting) are counted in baseband, in other words, on a signal whose instantaneous frequency is $f_r(t) - K * f_b(t)$, where :

- ⇒ $f_r(t)$ is the true frequency received,
- ⇒ $f_b(t)$ is the actual frequency of the onboard USO [with nominal value $f_{b0} = 10$ MHz]
- ⇒ The theoretical frequencies of the '400 MHz' and '2 GHz' RF channels are 401.25 MHz and 2036.25 MHz. As these are emitted by ground beacons, the frequencies received on each channel are affected by the Doppler effect related to the relative beacon/satellite motions.
- ⇒ K (f_b frequency multiplier giving the onboard reference frequency) has a different value according to the channel : $K_{400\text{MHz}} = 40.125$, $K_{2\text{GHz}} = 203.625$

The duration separating the moments E1 and E2 is perfectly known in TOUS time, in other words, according to the time base of the onboard USO. Thus, for the measurement taken in the Tdi sequence starting with the Tdi number k time signal,

- ⇒ $\text{TOUS}(E1) = \text{TOUS}(\text{Tdi-UC}_k) + \text{Dnc}/c + \text{Difference}(\text{BDT}(\text{UT}) - \text{BDT}(\text{UC}))$
- ⇒ $\text{TOUS}(E2) = \text{TOUS}(E1) + \text{TC}$

Where :

- ⇒ $\text{Difference}(\text{BDT}(\text{UT}) - \text{BDT}(\text{UC}))$ is measured by the instrument and transmitted in HK blocks (nominal value $\cong 1.8$ to 1.9 microseconds): in fact, several time bases coexist onboard, the UC time base and four time bases (UT1, 400 MHz), (UT1, 2 GHz), (UT2, 400 MHz), (UT2, 2 GHz) for which the onboard instruments measure the differences with respect to the UC time base.
- ⇒ Dnc/c (chained/unchained delay) is equal to:
 - 3 TOUS seconds in unchained mode;
 - 0 TOUS seconds in chained mode (or $-| \text{time correction} |$ if there is a time correction).
- ⇒ CT (counting time in TOUS) is equal to:
 - 7 TOUS seconds in unchained mode;
 - 10 TOUS seconds in chained mode (or $10 + | \text{time correction} |$ if there is a time correction)

The number of cycles transmitted in the DORIS telemetry (N2 parameter) is the number of cycles counted between E1 and E2 on the frequency signal $f_r(t) - K * f_b(t)$.

N2 transmitted is a real number (not necessarily an integer which is the difference between the 1st and 2nd generation DORIS receivers). The LSB (Less Significant Bit) of N2 is $1/1024$ cycle = $2\pi/1024$ radians.



Reference : CO-SP-D0-OP-14815-CN
 Issue : 4.2
 Date : 15/06/05
 Page : 13/34

Title : MODELLING OF DORIS 2GM AND CRYOSAT INSTRUMENTS

Thus, for each of the two measuring channels, we have :

$$N_2 = \int_{TAI(E1)}^{TAI(E2)} [f_r(t) - K * f_b(t)] dt = \int_{TAI(E1)}^{TAI(E2)} f_r(t) dt - K * \int_{TAI(E1)}^{TAI(E2)} f_b(t) dt \quad [E]$$

4.2.2.1 FIRST TERM OF THE EQUATION [E]

Let $\Phi(E_i)$ be the phase received at the instant E_i (respectively $i = 1$ or 2 for the beginning and end of counting), on the frequency signal $f_r(t)$, for the channel in question.

We are introducing here the concept of an 'emission' event; we call 'Fi' the event corresponding to the emission from the beacon phase centre of the phase $\Phi(E_i)$ – whose arrival at the onboard counter becomes event E_i .

T_{pi} is the duration measured in TAI, between the events F_i and E_i : $T_{pi} = TAI(F_i, E_i)$. T_{pi} is referred to by the generic term of propagation time.

Since the number of cycles received onboard is equal to the number of cycles transmitted by the beacon, the first term is written as follows:

$$\int_{TAI(E1)}^{TAI(E2)} f_r(t) dt = \int_{TAI(F1)}^{TAI(F2)} f_e(t) dt = \int_{TAI(E1)-Tp1}^{TAI(E2)-Tp2} f_e(t) dt$$

in which $f_e(t)$ is the frequency emitted by the beacon, on the channel in question, at the TAI time t .

The frequency emitted by the beacon is obtained by multiplying the frequency generated by the ground USO:

- ⇒ $f_e(t) = H * f_s(t)$ in which H is intentionally constant by construction,
- ⇒ $f_s(t)$ is the real frequency of the ground USO [with nominal value $f_{s0} = 5$ MHz].
- ⇒ H has a different value depending on the channel and depending on the value of the k factor of the beacon frequency offset (3G beacon only, see section 4.1 of DA2) :

$$H_{400\text{ MHz}} = 80.25 + \frac{107 \times 87\text{ k}}{5 \times 2^{26}} \quad H_{2\text{ GHz}} = 407.25 + \frac{543 \times 87\text{ k}}{5 \times 2^{26}}$$

This then gives:

$$\int_{TAI(E1)}^{TAI(E2)} f_r(t) dt = \int_{TAI(E1)-Tp1}^{TAI(E2)-Tp2} f_e(t) dt = H * \int_{TAI(E1)-Tp1}^{TAI(E2)-Tp2} f_s(t) dt$$



Reference : CO-SP-D0-OP-14815-CN
 Issue : 4.2
 Date : 15/06/05
 Page : 14/34

Title : MODELLING OF DORIS 2GM AND CRYOSAT INSTRUMENTS

Using equation [C], we then get :

$$\int_{TAI(E1)}^{TAI(E2)} f_r(t) dt = H * [(TAI(E2) - Tp2) - (TAI(E1) - Tp1)] * f_{s0} * (1 + \frac{\overline{\delta f_s}}{f_{s0}}) \quad [F]$$

using, $\overline{\delta f_s}$ (to simplify the notation) for the mean value of $f_s(t) - f_{s0}$, between the events F1 and F2.

4.2.2.2 SECOND TERM OF THE EQUATION [E]

The second term of the equation [E] can be written using the expression [D]:

$$K * \int_{TAI(E1)}^{TAI(E2)} f_b(t) dt = K * f_{b0} * TC$$

Written in this way (in TOUS time), it only depends on the measuring channel (2 GHz/400 MHz) and on the mode (chained/unchained). In particular, it does not rely on the onboard USO actual frequency.

Actually, in order to continue the calculations, we will need to formulate the expression directly in TAI, in other words to use equation [C] :

$$K * \int_{TAI(E1)}^{TAI(E2)} f_b(t) dt = K * (TAI(E2) - TAI(E1)) * f_{b0} * (1 + \frac{\overline{\delta f_b}}{f_{b0}}) \quad [G]$$

4.2.2.3 THEORETICAL EXPRESSION OF N2 COUNTINGS

Using [E], [F] and [G], we then get:

$$N2 = H * f_{s0} * (TAI(E2) - T_{p2} - TAI(E1) + T_{p1}) * (1 + \frac{\overline{\delta f_s}}{f_{s0}}) - K * (TAI(E2) - TAI(E1)) * f_{b0} * (1 + \frac{\overline{\delta f_b}}{f_{b0}}) \quad [H]$$

Comment: For a beacon which does not have a frequency offset (k=0), by writing $F_{nom} = H * f_{s0} = K * f_{b0}$, we can isolate the term due to the Doppler effect :

$$N2 = -F_{nom} * (T_{p2} - T_{p1}) * (1 + \frac{\overline{\delta f_s}}{f_{s0}}) + F_{nom} * TAI(E1, E2) * (\frac{\overline{\delta f_s}}{f_{s0}} - \frac{\overline{\delta f_b}}{f_{b0}})$$

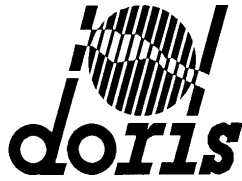

4.3 PSEUDO-RANGE MEASUREMENT PRINCIPLE

The value of IT_3 corresponds to the difference between the TCMD time pulse and the raising edge of the first zero of the synchronisation word.

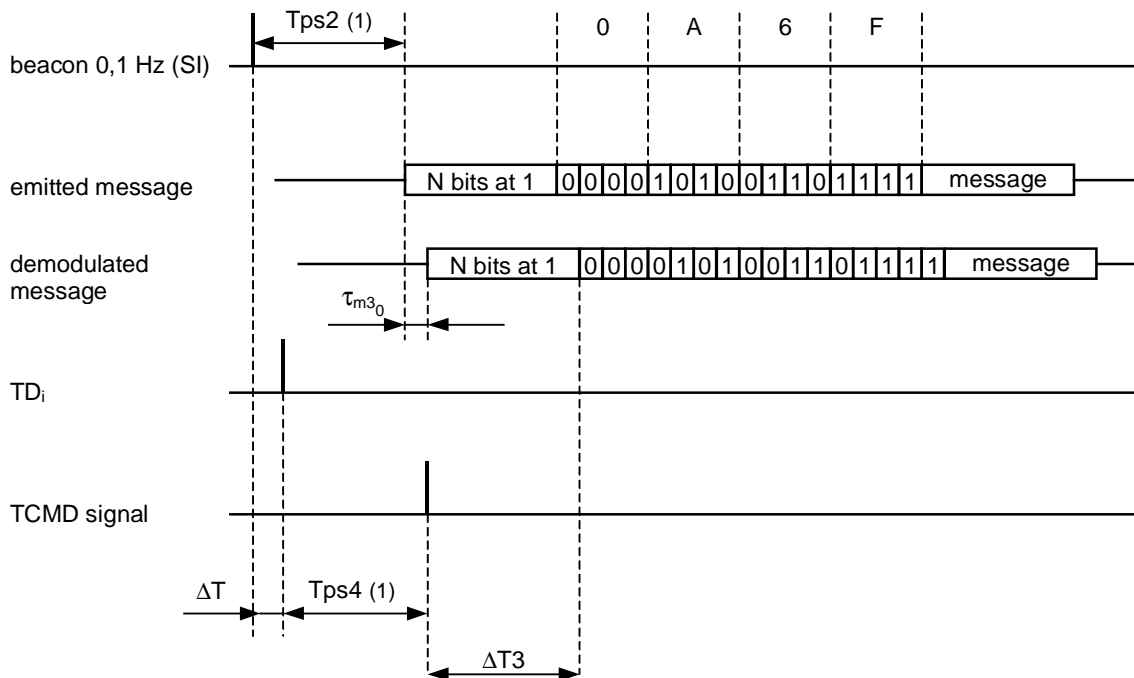

(1) Constructor convention :

$Tps_2 = 2.1$ s for a master beacon with $N = 120$
 4.9 s for the other first and second generation beacons with $N = 80$
 4.7 s for the other third generation beacons with $N = 120$
(emission duration of a bit=5 milliseconds, no matter what the beacon type and generation)

$Tps_4 =$ difference between the TD_i pulse and the TCMD pulse = $3 \cdot 10^7 / FOUS = 3$ s nominally.

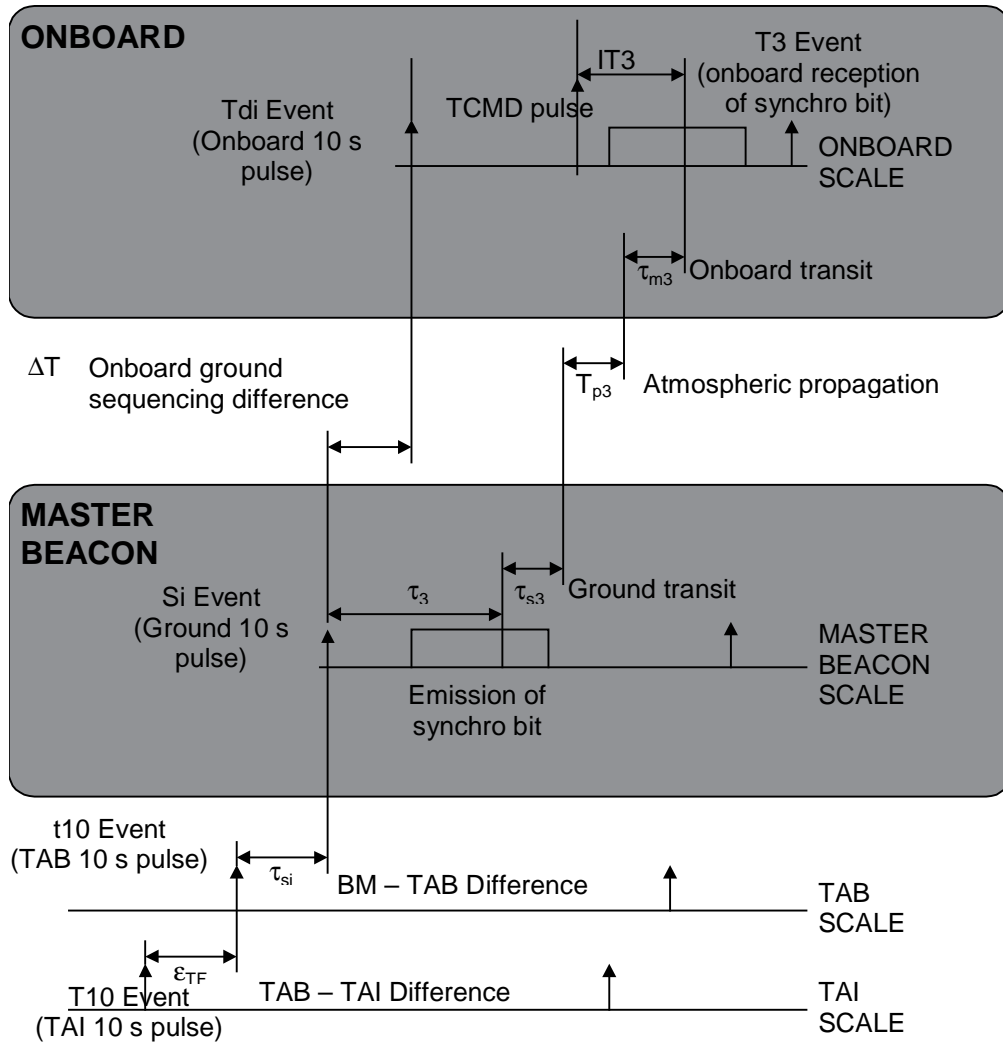
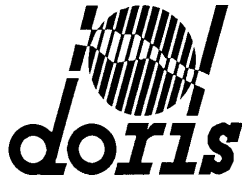

Figure 1 : Diagram showing the time-tagging measurement principle (TAB = TAC or TAK)

Nominally, $\Delta T = -1.15 \text{ s} \pm 50 \text{ ms}$ on DORIS/JASON-1, DORIS/SPOT 5 and DORIS/CRYOSAT.

4.4 MODELING OF THE PSEUDO-RANGE MEASUREMENT

To be specified in a later issue.



Reference : CO-SP-D0-OP-14815-CN
Issue : 4.2
Date : 15/06/05
Page : 17/34

Title : MODELLING OF DORIS 2GM AND CRYOSAT INSTRUMENTS

5. MODELS

Depending on the case, the delays are represented by a time or by a phase difference for the given frequency.

5.1 GROUND

The ground models are described in the DA1 document.

5.2 PROPAGATION (T_p)

Total propagation time $T_{pi} = T_{ei} + \tau_{eias} + \tau_{eiab}$

τ_{eias} and τ_{eiab} include the combination of ground and onboard antenna phase laws which depend on the propagation direction in the corresponding antenna reference frames.

T_{ei} : propagation time between the 2 phase centres of the onboard and ground antennas :

$$T_{ei} = T_{geo} + T_{iono} + T_{tropo}$$

The definition of ϕ and θ is given for the ground antenna in figure 4 in DA1. The azimuth ϕ and site θ phase laws for the ground antenna are used to evaluate τ_{eias} and are described in section 5.1.2.3 of DA1.

The definition of ϕ and θ is given for the onboard antenna in section 5.3.3. The azimuth ϕ and elevation θ phase laws for the onboard antenna are used to evaluate τ_{eiab} and are described in section 5.3.3.3 of this document.

5.3 ONBOARD INSTRUMENTS

5.3.1 ONBOARD USO FREQUENCY

The onboard USO frequency f_b is identical for both channels.

$f_{b0} = 10$ MHz.

The real frequency of the onboard USO f_b evolves over time due to different parameters:

- ⇒ Ageing,
- ⇒ Thermal variations,
- ⇒ Magnetic variations,
- ⇒ Radiation,
- ⇒ ...

f_b (current, voltage, thermal, magnetic, ageing, radiations, ...): model TBD

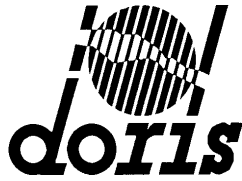

Reference : CO-SP-D0-OP-14815-CN
Issue : 4.2
Date : 15/06/05
Page : 18/34

Title : MODELLING OF DORIS 2GM AND CRYOSAT INSTRUMENTS

5.3.2 MVR INSTRUMENT (*MESUREUR DE VITESSE RADIALE*)

5.3.2.1 *Doppler measurements at 'central frequency'*

When the 'Doppler frequency' at the MVR level is close to 0, it is difficult to determine the phase of the received signal due to strong perturbation. N2 phase increment measurements, for which the Doppler frequency is close to 0 during counting, have to be eliminated by the ground processing .

Criteria for elimination which are compatible with the Jason-1, SPOT5 and CRYOSAT orbits are :

In chained mode:

- The **mean** radial velocity of the measurement derived from the 400 MHz or 2 GHz measurement is taken to be between, **-310 m/sec and + 310 m/sec**
- or, the **mean** Doppler frequency of the measurement, is between **- 415 Hz and +415 Hz for the 400 MHz channel** or between **- 2105 Hz and +2105 Hz for the 2 GHz channel**
- or in terms of cycles, if the **number of cycles measured** is between **- 4150 cycles and+ 4150 cycles for the 400 MHz channel** or between **- 21050 cycles and+ 21050 cycles for the 2 GHz channel**

In unchained mode

- the **mean** radial velocity of the measurement derived from the 400 MHz or 2 GHz measurement is between **- 220 m/sec and + 220 m/sec**
- or the **mean** Doppler frequency of the measurement is between **- 295 Hz and+ 295 Hz for the 400 MHz channel** or between **- 1495 Hz and +1495 Hz for the 2 GHz channel**
- or in terms of cycles, if the **number of cycles measured** is **between - 2065 cycles and + 2065 cycles for the 400 MHz channel** or between **- 10465 cycles and + 10465 cycles for the 2 GHz channel**

5.3.2.2 *Invalidation of uncompleted received measurements*

For strongly time-shifted beacons (and/or for beacons in restart mode RS=1), the Tdi pulse of the 'next' sequence may occur during reception of the modulation.

When this pulse occurs during the reception of the synchronisation word ("0A6F"H), the on-board software invalidates the IT3 measurement.

In every other case (Tdi pulse during the reception of the beacon message, or during the reception of the two ICCE words (Error Correcting Code)), the IT3 measurement is performed and the on-board software does not invalidate it : since the message will be incomplete, this kind of measurement should be invalidated by the ground segment.

Thus it is recommended to invalidate the measurements when :

- IT3 > 6.5 sec (if the IT3 measurement is done on the 400 MHz channel),
> 6.2 sec (if it is done on the 2 GHz channel)



Reference : CO-SP-D0-OP-14815-CN
 Issue : 4.2
 Date : 15/06/05
 Page : 19/34

Title : MODELLING OF DORIS 2GM AND CRYOSAT INSTRUMENTS

5.3.2.3 Onboard Doppler transit time

$\varepsilon_{fr} = 0$, no model available

τ_{m1} and τ_{m2} (respectively at the beginning of counting and the end of counting) are given in the following table:

Transition time (microseconds)	JASON-1 FM2 (chain 1)		JASON-1 FM23 (chain 2)		SPOT5	
	UT1	UT2	UT1	UT2	UT1	UT2
τ_m 400 MHz	71.73	71.73	71.72	71.72	56.54	56.54
τ_m 2 GHz	49.09	49.09	49.08	49.08	46.13	46.13

Transition time (microseconds)	CRYOSAT (chain 1)		CRYOSAT (chain 2)	
	UT1	UT2	UT1	UT2
τ_m 400 MHz	56.61	56.61	56.61	56.61
τ_m 2 GHz	46.13	46.13	46.13	46.13

5.3.2.4 Onboard transit time for the time-tagging bit

In theory, τ_{m3} is a function of the Doppler shift, of the level received and of the temperature of the MVR. In practice, these effects are measured by the manufacturer and are sufficiently low to be neglected. We thus apply the following simplified formula:

$$\tau_{m3} = \tau_{m3_0}$$

in which τ_{m3_0} , the vacuum transit time, at f_0 , at the reference reception level (- 113 dBm), at 20°C, is a constant given in the following table:



Reference : CO-SP-D0-OP-14815-CN

Issue : 4.2

Date : 15/06/05

Page : 20/34

Title : MODELLING OF DORIS 2GM AND CRYOSAT INSTRUMENTS

Instrument		τ_{m3_0} (μ sec) 400 MHz channel	τ_{m3_0} (μ sec) 2 GHz channel
DORIS/JASON-1 chain 1 (FM2)	UT1	879.2	327.1
	UT2	879.2	327.1
DORIS/JASON-1 chain 2 (FM23)	UT1	879.0	327.1
	UT2	879.0	327.1
DORIS/SPOT 5	UT1	863.5	324.0
	UT2	863.5	324.0
DORIS/CRYOSAT chain 1	UT1	864.0	324.0
	UT2	864.0	324.0
DORIS/CRYOSAT chain 2	UT1	864.0	324.0
	UT2	864.0	324.0

NB:

At the central frequency (null Doppler) an aberrant time-tagging (with an error of a few tens of microseconds) may occur.

5.3.3 ONBOARD ANTENNAS

Z is the onboard geocentric-centripetal axis.

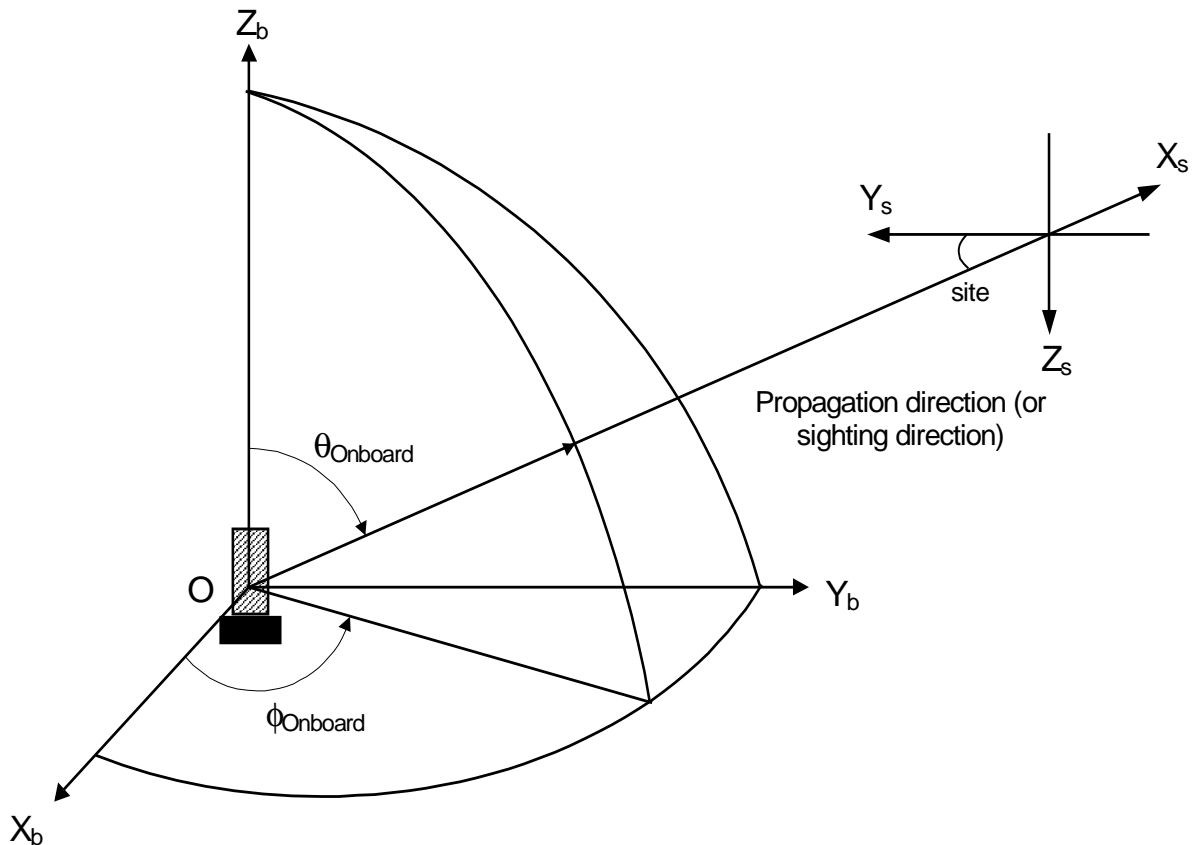

Figure 2 : Antenna reference frame
(O = phase centre)

The site and θ_{onboard} angles are linked by the following formula:

$$\theta_{\text{onboard}} = \text{Arc sin} \left(R \frac{\cos(\text{Site})}{(R + h)} \right)$$

in which R = earth radius = 6378 (km)

h = satellite altitude(km)

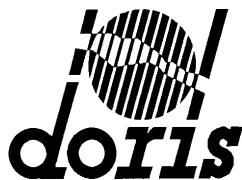

Reference : CO-SP-D0-OP-14815-CN
 Issue : 4.2
 Date : 15/06/05
 Page : 22/34

Title : MODELLING OF DORIS 2GM AND CRYOSAT INSTRUMENTS

5.3.3.1 Geometry of onboard antennas

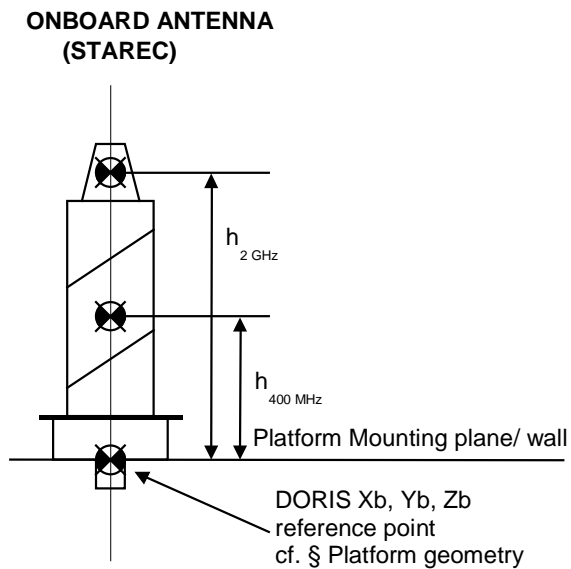

Figure 3

Antenna	Onboard SPOT 5 STAREC type	Onboard JASON-1 STAREC type	Onboard CRYOSAT STAREC type
h (mm) 400 MHz	153	156	154
h (mm) 2 GHz	315	324	319



Reference : CO-SP-D0-OP-14815-CN
Issue : 4.2
Date : 15/06/05
Page : 23/34

Title : MODELLING OF DORIS 2GM AND CRYOSAT INSTRUMENTS

5.3.3.2 Gains (dBi)

Site (°)	θ_{onboard} (°)	SPOT 5	
		400	2 G
90	0.0	5.2	4.7
80	8.83	5.0	4.5
70	17.61	4.9	4.2
60	26.25	4.3	3.8
50	34.65	3.5	3.4
40	42.66	2.7	2.9
30	50.0	1.8	2.2
20	56.23	0.7	1.6
10	60.6	0.1	1.2
0	62.2	-0.1	0.8

Site (°)	θ_{onboard} (°)	JASON-1	
		400	2 G
90	0.0	5.9	4.6
80	8.24	5.9	4.6
70	16.4	5.8	4.4
60	24.37	5.4	4.0
50	32.04	4.8	3.4
40	39.21	4.2	3.0
30	45.62	3.4	2.5
20	50.85	2.6	2.0
10	54.37	2.0	1.6
0	55.62	1.6	1.5

Site (°)	θ_{onboard} (°)	CRYOSAT	
		400	2 G
90	0.0	5.2	4.3
80	8.99	5.0	4.3
70	17.92	4.7	4.1
60	26.73	4.4	3.7
50	35.32	3.7	3.2
40	43.55	3.0	2.8
30	51.16	2.0	2.0
20	57.69	1.0	1.5
10	62.35	0.0	1.0
0	64.09	-0.3	0.7



Reference : CO-SP-D0-OP-14815-CN
 Issue : 4.2
 Date : 15/06/05
 Page : 24/34

Title : MODELLING OF DORIS 2GM AND CRYOSAT INSTRUMENTS

5.3.3.3 Phase laws

Azimuth phase law (written ϕ_{onboard}) :

$\psi(\phi_{\text{onboard}}) = \text{cte} - \phi_{\text{onboard}} \pm \varepsilon$, in which ε is given by the following table:

	SPOT 5		JASON-1		CRYOSAT	
	400 MHz	2 GHz	400 MHz	2 GHz	400 MHz	2 GHz
ε°	2.0	2.0	2.0	1.5	2.0	2.0

Site phase law (written θ_{onboard}) :

$\psi(\theta_{\text{onboard}}) = \text{cte} \pm \varepsilon$, in which ε is given by the following table:

	SPOT 5		JASON-1		CRYOSAT	
	400 MHz	2 GHz	400 MHz	2 GHz	400 MHz	2 GHz
ε°	2.5	2.0	3.0	2.0	1.5	3.0

5.3.4 LOSSES DUE TO ONBOARD CABLES

These are cables linking the antenna to the MVR. They are given in Db.

	JASON-1		SPOT 5	CRYOSAT	
	MVR FM2 (chain 1)	MVR FM2 (chain 2)		(chain 1)	(chain 2)
400 MHz channel	-0.25	-0.19	-0.14	0.41	0.41
2 GHz channel	-0.55	-0.46	-0.62	0.8	0.79



Reference : CO-SP-D0-OP-14815-CN
Issue : 4.2
Date : 15/06/05
Page : 25/34

Title : MODELLING OF DORIS 2GM AND CRYOSAT INSTRUMENTS

5.3.5 PLATFORM GEOMETRY

The mass and position of the centre of gravity may evolve during orbit life. These parameters have to be monitored during operations. Given their slow evolution, it is sufficient to record the values after each big manoeuvre.

In-orbit thermal cycling creates a sinusoidal phase variation which mainly affects the multiplication chain. This effect has an impact on the Doppler measurement similar to the USO thermal cycling effect (cf. § 5.3.1) but remains less significant than the latter.

The two local orbital reference frames currently used are called P, R, Y (Pitch, Roll, Yaw), and R, N, T (Radial, Tangential, Normal). The correspondence is as follows :

Pitch = - Normal,
Roll = Tangential,
Yaw = Radial.

5.3.5.1 SPOT5 Satellite

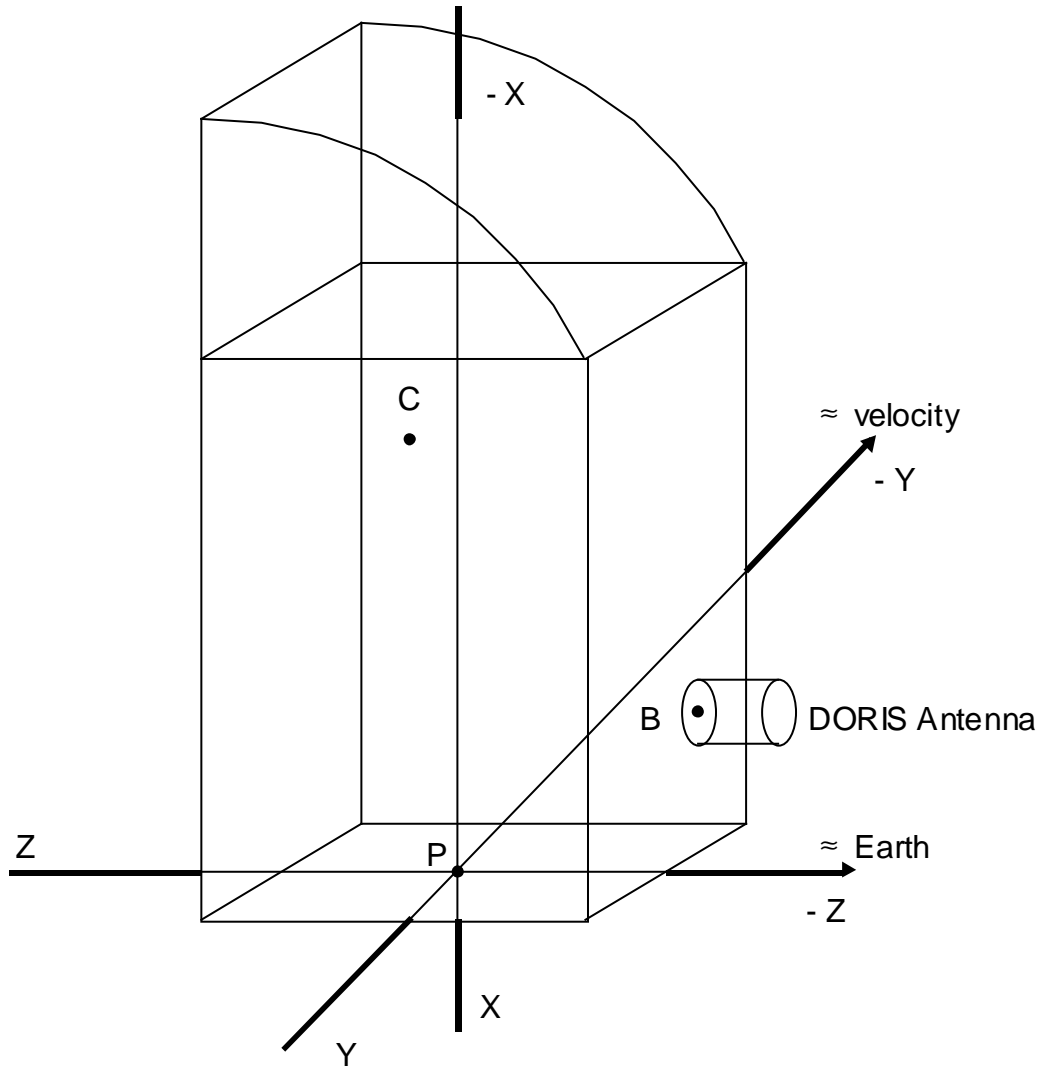

Figure 4 : Position of DORIS antenna on the SPOT5 satellite

- C : satellite centre of gravity
- B : DORIS antenna reference point
- P : satellite mounting plane centre



Reference : CO-SP-D0-OP-14815-CN
 Issue : 4.2
 Date : 15/06/05
 Page : 27/34

Title : MODELLING OF DORIS 2GM AND CRYOSAT INSTRUMENTS

Satellite	SPOT 5
xB (m)	-0.520
yB (m)	-0.480
zB (m)	-1.100
xC (m) (1)	-1.990 (2)
yC (m) (1)	+0.004 (2)
zC (m) (1)	+0.006 (2)
Satellite mass (on orbit) (kg)(1)	3041 (3)

NB:

(1) This value evolves over time

(2) Value at beginning of life.

(3) Value after station positioning and MCC 1st station keeping manoeuvre in mid-September 2002.

The components of vector from the Centre of Gravity to the 2 GHz phase centre in the platform reference frame are thus (approximately) :

Satellite	SPOT 5
X (m)	1.470
Y (m)	-0.484
Z (m)	-1.421

With:

$$X (m) = xB (m) - xC (m)$$

$$Y (m) = yB (m) - yC (m)$$

$$Z (m) = zB (m) - zC (m) - h_{2\text{GHz}} (m)$$

The nominal attitude is geocentric. The pitch-axis is - X, the roll-axis is - Y, the yaw axis is + Z. The satellite is driven by a yaw movement whose law is described in DR12.

When all angles (roll, pitch, yaw) are null, the transition matrix for switching from the platform reference frame to the local reference frame T, R, L is thus:

$$\begin{pmatrix} X_{ol} \\ Y_{ol} \\ Z_{ol} \end{pmatrix} = \begin{pmatrix} -1.0 & 0.0 & 0.0 \\ 0.0 & -1.0 & 0.0 \\ 0.0 & 0.0 & 1.0 \end{pmatrix} \begin{pmatrix} X_{pf} \\ Y_{pf} \\ Z_{pf} \end{pmatrix}$$

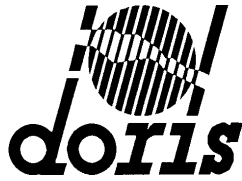

Reference : CO-SP-D0-OP-14815-CN
Issue : 4.2
Date : 15/06/05
Page : 28/34

Title : MODELLING OF DORIS 2GM AND CRYOSAT INSTRUMENTS

Satellite surfaces:

$\perp \vec{X}$ side : 7.21 m²
 $\perp \vec{Y}$ side : 10.79 m²
 $\perp \vec{Z}$ side : 11.79 m²
Solar array : 24.795 m²

5.3.5.2 JASON-1 Satellite

The description of the platform reference frame is given in **ANNEX 1**.

Satellite	JASON-1
x_B (m)	1.171
y_B (m)	-0.598
z_B (m)	0.703
x_C (m) (1)	0.937
y_C (m) (1)	0.0
z_C (m) (1)	0.0
Satellite mass (on orbit) (kg) (1)	487

(1) This value evolves over time

The components of the vector from the Centre of Gravity to the 2 GHz phase centre in the platform reference frame are thus (approximately) :

Satellite	JASON-1
X (m)	0.234
Y (m)	-0.598
Z (m)	1.027

The satellite's attitude is complex (yaw steering, nadir pointing, fixed law phases). It is defined in the DR11 document, section. 5.

The roll axis is + X, the pitch axis is + Y and the yaw axis is + Z.



Reference : CO-SP-D0-OP-14815-CN
 Issue : 4.2
 Date : 15/06/05
 Page : 29/34

Title : MODELLING OF DORIS 2GM AND CRYOSAT INSTRUMENTS

The transition matrix for switching from the platform reference frame to the local reference frame T, R, L is thus:

$$\begin{pmatrix} X_{ol} \\ Y_{ol} \\ Z_{ol} \end{pmatrix} = \begin{pmatrix} 0.0 & 1.0 & 0.0 \\ 1.0 & 0.0 & 0.0 \\ 0.0 & 0.0 & -1.0 \end{pmatrix} \begin{pmatrix} X_{pf} \\ Y_{pf} \\ Z_{pf} \end{pmatrix}$$

Satellite surfaces:

- ⊥ \vec{X} side : 1.65 m²
- ⊥ \vec{Y} side : 3.0 m²
- ⊥ \vec{Z} side : 3.1 m²
- Solar arrays : 9.80 m² (i.e. 4.9 m² for each wing)

5.3.5.3 CRYOSAT Satellite

The description of the platform reference frame is given in **ANNEX 2**.

Satellite	CRYOSAT
xB (m)	1.8175
yB (m)	- 0.2001
zB (m)	- 0.4415
xC (m) (1)	1.5855 (2)
yC (m) (1)	0.0160 (2)
zC (m) (1)	- 0.0020 (2)
Satellite mass (on orbit) (kg) (1)	669 (2)

NB:

- (1) This value evolves over time
- (2) Value before launch

The antenna axis vector has the following components in the platform reference frame :

$$\vec{u} = \overrightarrow{DORIS(400MHz) \ DORIS(2GHz)} = \begin{pmatrix} 17.3 \text{ mm} \\ 0.0 \text{ mm} \\ -164.1 \text{ mm} \end{pmatrix}$$

(the antenna is tilted of 6° w.r.t. the platform reference frame)

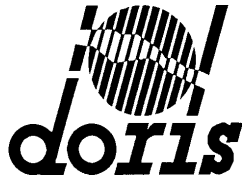

Reference : CO-SP-D0-OP-14815-CN
Issue : 4.2
Date : 15/06/05
Page : 30/34

Title : MODELLING OF DORIS 2GM AND CRYOSAT INSTRUMENTS

Note that calculated $NORM(\vec{u}) = 165 \text{ mm}$.

The components of the vector from the Centre of Gravity to the 2 GHz phase centre in the platform reference frame are then calculated :

Satellite	CRYOSAT
X (m)	0.2654
Y (m)	-0.2161
Z (m)	-0.7568

The nominal satellite attitude is practically geocentric with an offset of 6 degrees in pitch (see DR14). The roll axis is close to +X, the pitch axis is + Y, the yaw axis is close to + Z.

When all of the angles (roll, pitch, yaw) are null, the transition matrix for switching from the platform reference frame to the local orbital reference frame T, R, L is thus close to:

$$\begin{pmatrix} X_{ol} \\ Y_{ol} \\ Z_{ol} \end{pmatrix} = \begin{pmatrix} 0.0 & -1.0 & 0.0 \\ 1.0 & 0.0 & 0.0 \\ 0.0 & 0.0 & 1.0 \end{pmatrix} \begin{pmatrix} X_{pf} \\ Y_{pf} \\ Z_{pf} \end{pmatrix}$$

Satellite surfaces:

$\perp \vec{X}$ side : 2.515 m²

$\perp \vec{Y}$ side : 5.114 m²

$\perp \vec{Z}$ side : 8.882 m²

Solar arrays : 0.0 m² (on Cryosat Solar array is included in Space Craft body)



Reference : CO-SP-D0-OP-14815-CN

Issue : 4.2

Date : 15/06/05

Page : 31/34

Title : MODELLING OF DORIS 2GM AND CRYOSAT INSTRUMENTS

ANNEX 1 : DEPLOYED CONFIGURATION OF JASON-1 SATELLITE

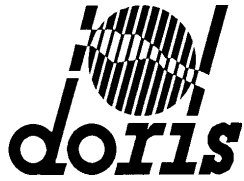

Reference : CO-SP-D0-OP-14815-CN

Issue : 4.2

Date : 15/06/05

Page : 32/34

Title : MODELLING OF DORIS 2GM AND CRYOSAT INSTRUMENTS

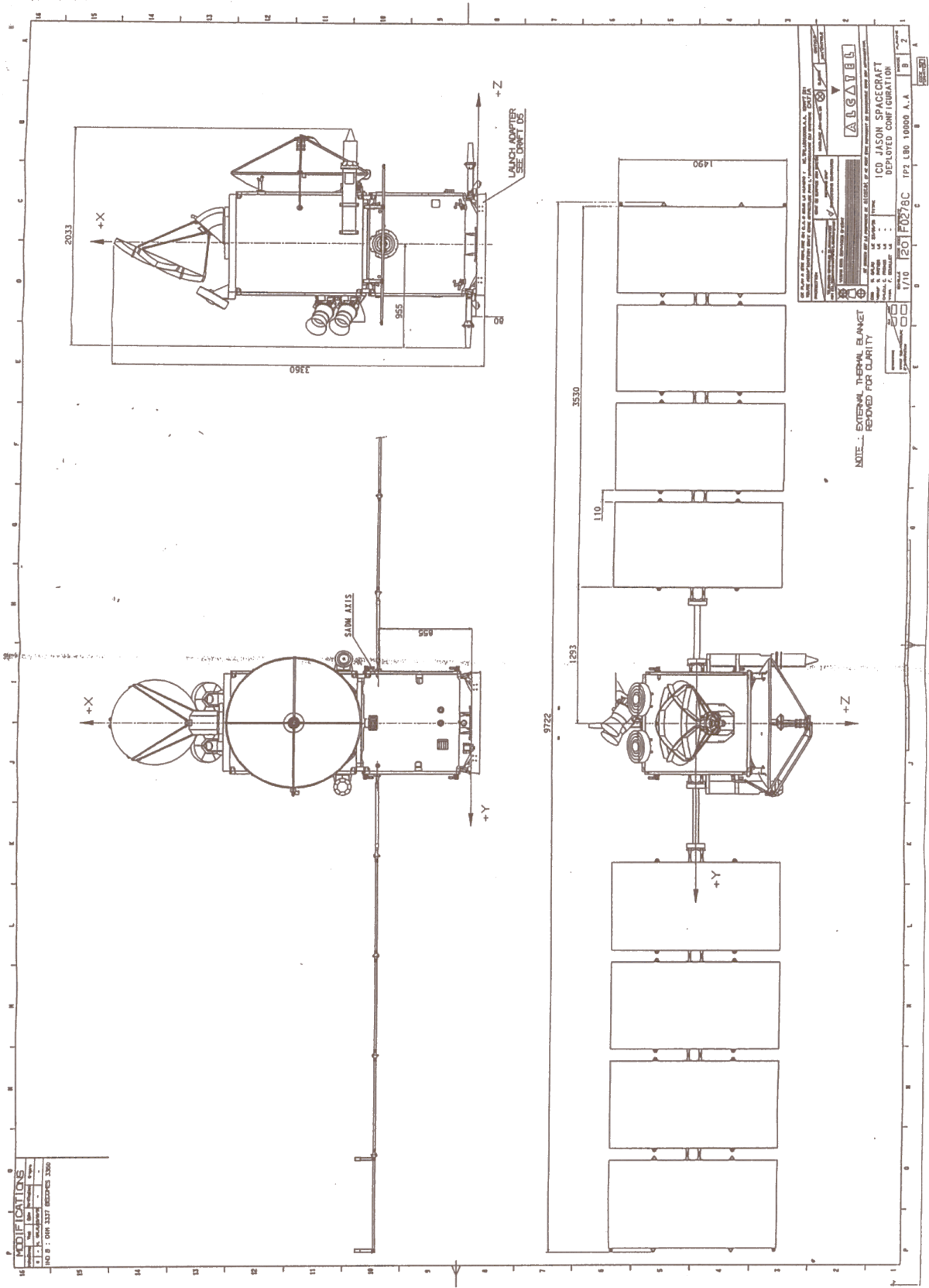

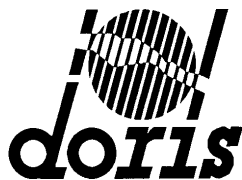

Reference : CO-SP-D0-OP-14815-CN
Issue : 4.2
Date : 15/06/05
Page : 33/34

Title : MODELLING OF DORIS 2GM AND CRYOSAT INSTRUMENTS

ANNEX 2 : CRYOSAT SATELLITE REFERENCE FRAME

(see DR14 for more details)

A view of the CryoSat satellite, indicating the satellite reference frame is provided in Figure 2.1-1. The satellite flies in a "nose-down" attitude, inclined at 6° to the positive x-axis. The nadir direction is inclined 6° from the negative z-axis.

The origin of the satellite reference frame is at the centre of the satellite mounting plane on the launch vehicle.

There are no moving parts.

Figure 2.1-1 The CryoSat satellite, shown without the thermal control material which will be used to wrap the large antennas and their support structure. The satellite reference frame is shown as well as the directions of flight and nadir. Note that for the z-axis the negative axis is shown in order to show the offset of the nadir direction.

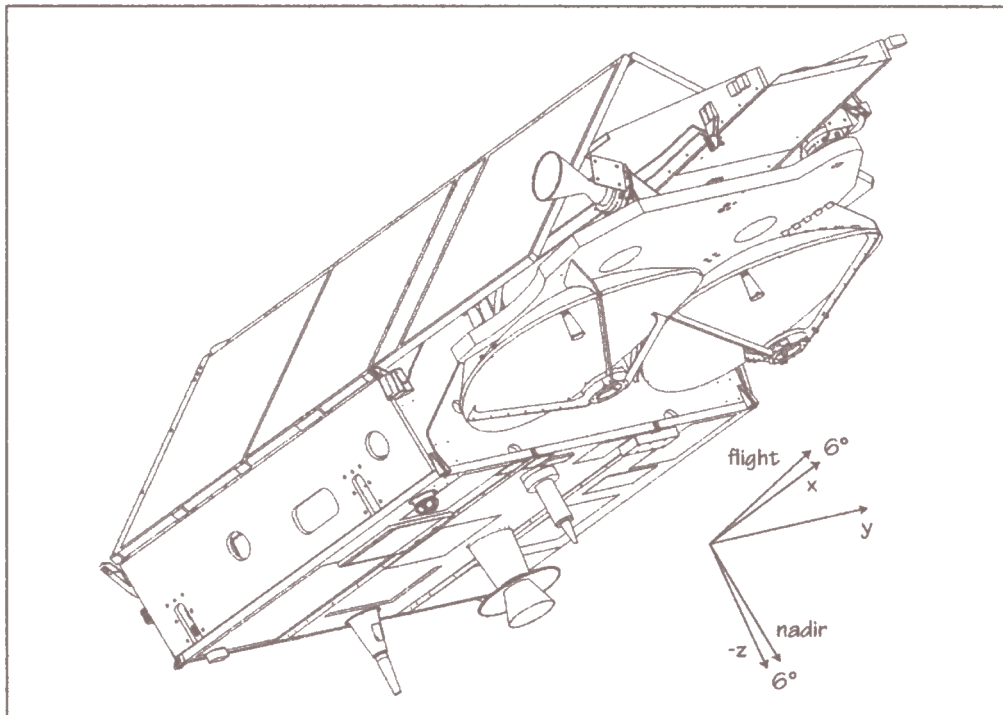



Reference : CO-SP-D0-OP-14815-CN
 Issue : 4.2
 Date : 15/06/05
 Page : 34/34

Title : MODELLING OF DORIS 2GM AND CRYOSAT INSTRUMENTS

DISTRIBUTION

CNES Distribution:

			document	1 st page
P. ESCUDIER		BP 2002	X	
J. PERBOS		"		X
A. AURIOL		"	X	
C. JAYLES		"	X	
P. SENGENES		"	X	
I. FRATTER		"	X	
F. ROZO		"	X	
M. DEJUS		"		
M. VIVIES		"		X
S. COUTIN-FAYE		"	X*	
N. MALECHAUX		"	X*	
J. NOUBEL		"	X*	
G. TAVERNIER		"	X*	
P. VINCENT		"		
N. PICOT		"		X*
JP. GRANIER		"	X*	
D. SCHOLLER		"		
DORIS documentation		"	X	
SALP documentation		"	X	
JM. LOPEZ		BP 112		
C. JOUVE		BP 3602	X	
M. BRUNET		BP 2013		
JF. DUTREY		"		
G. KEIL		BP 1415		X
F. MERCIER		BP 1323	X*	
S. HOURY		"	X*	
P. BOUDOU		BP 1501		X*
L. CLARAC		"	X*	
MH. GOMEZ		BP 2513		
F. de DGUEBOUADZE		BP 1605		

External Distribution :

			document	1 st page
P. SOUTY	THALES AIRBORNE SYSTEMS		X	
H. FAGARD	IGN		X	
A. BOURIDAH	ESA		X	
C. MAVROCORDATOS	ESA		X	
P. THEBAULT	DACTEM			
M. MIDROIT	SMP			
M. DESTOUESSE	CLS		X* BE exploitation	

* sous/couvert configuration SALP